

BOXED PRODUCTS

IN STOCK & READY TO SHIP IN 1-3 BUSINESS DAYS



3 UNIQUES

What are the three points of difference that Kattsafe has and nobody can compete with?

1

We Deliver a Healthy Roof™

End to End Solution. Delivering peace of mind from audit to system supply and installation, ongoing maintenance and ultimate peace of mind and compliance.

2

Modular Aluminum Products

Aluminum construction allows for on-site customization and easier handling. Modular design allows for ultimate adjustability in the field as well as quick order turnaround.

3

Unmatched Technical and Partner Support

Our customers can rely on us to give them accurate and best in class advice which gives confidence and peace of mind. We go the extra mile every time.

Commercial building height access and fall protection requirements

Simpler systems are safer systems. That's why at Kattsafe we design and manufacture industry-leading, high-spec products for height safety and access systems that deliver maximum safety with minimum fuss. But 'good' is never enough for us and we continue to push the standards of safety forward with each innovation we develop.

Because when it comes to protecting lives, there are no shortcuts.

For more information please contact Kattsafe.
www.kattsafe.com

- 1 Crossovers
- 2 Guardrail
- 3 Walkway
- 4 Fixed ladders
- 5 Roof hatches
- 6 Roof hatch guardrail

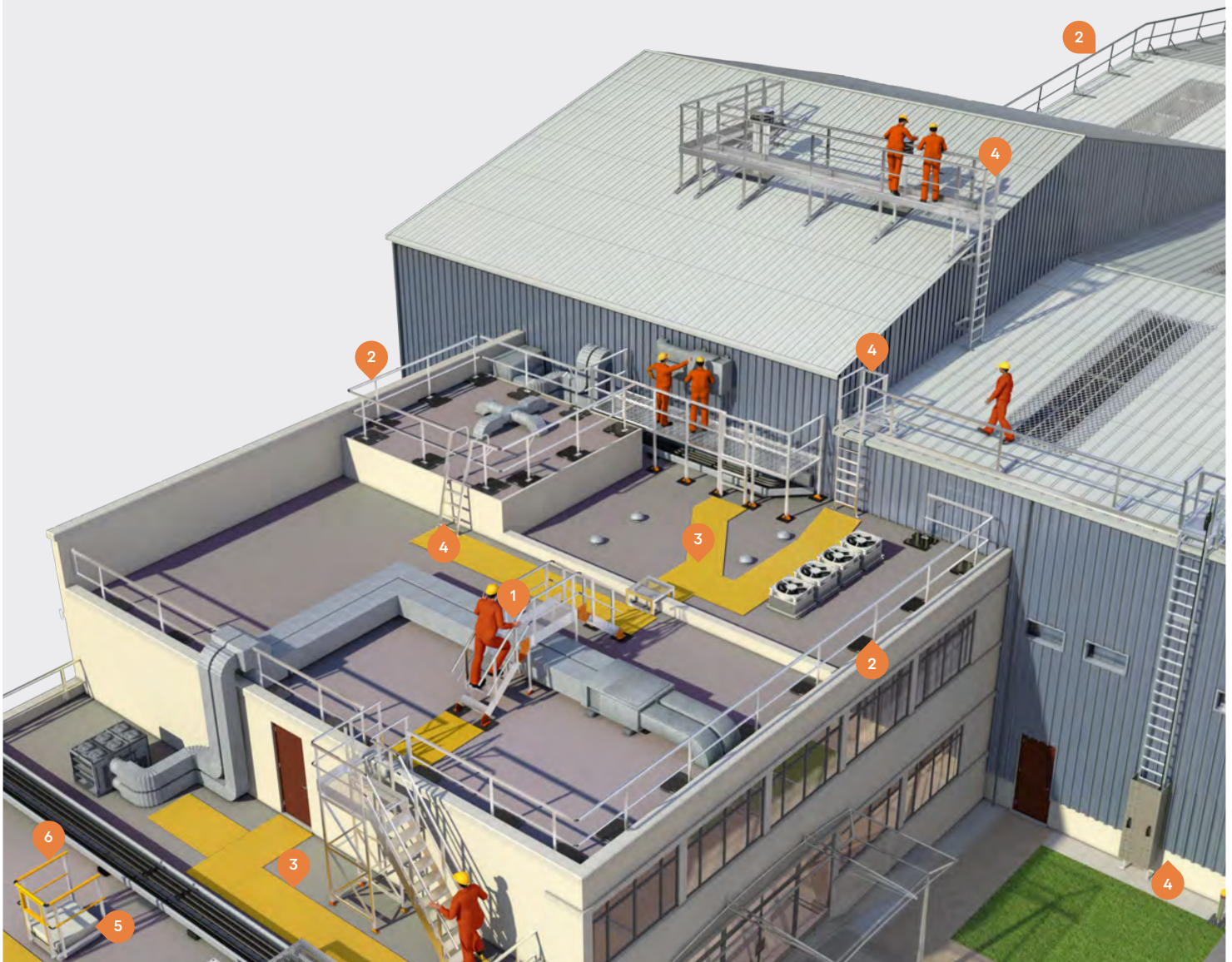

FIXED LADDER SYSTEMS

RL20 series angled fixed ladders

Ergonomic solution for access between varying roof levels up to 16ft.



RL30 series vertical fixed ladders

Standard ladder option made from high-tensile, lightweight aluminum.



RL40 series caged fixed ladders

Constructed of aluminum, these caged fixed ladders are lightweight, sturdy, and non-corrosive.



LADDER FALL ARREST

Ladder fall arrest system

Ladder fall arrest solution that integrates with the Kattsafe ladders and can also be retrofitted to existing OSHA compliant fixed ladders.



Ladder fall arrest traveler device

A minimum fuss traveler device that is exclusively used with the Kattsafe ladder fall arrest system.



Energy shock absorber

Energy absorbing lanyard attaches to the traveler device and to the front chest D-ring of an approved fall arrest safety harness.



Full body harness with front D-ring

The front D-ring harness will be needed to complete the ladder arrest system.



FIXED LADDER ACCESSORIES

GW390/GW390A Self-closing gate



LD426 Security door



LD425 Cage gate



LD427 Hinged security door



KD401 Wall/parapet ladder support bracket



KD402 Roof mount ladder support bracket

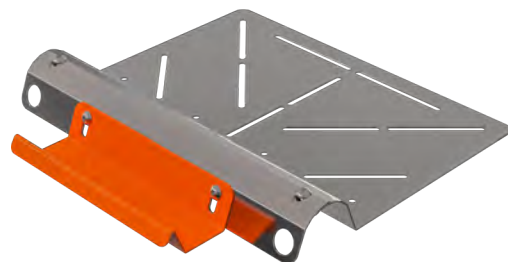

CROSSOVER STAIRS

KC103 modular crossover systems

Allows for safe access over pipes, expansion joints, and equipment or up to elevated areas. Custom sizes available.



Each system includes

- (2) Pre-configured stair modules
- 36in x 36in platform
- Top rail, mid rail, and post kits
- Base mounting method
- 3ft width. Other widths available

KBMK.180

Freestanding option. Each kit contains (1) 5ft long support extrusion and hardware for a cost effective mounting option.

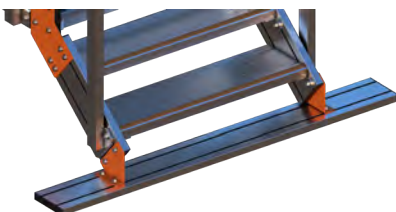

KBMK.KP.XX

Mechanically attached option. Each kit contains (2) roof deck attachment anchors with roof specific membrane attached.



KBMK.1WB

Freestanding option. Each kit contains (2) 12in x 12in plastic coated steel bases weighing 21lbs each.



MODULAR RAMP

KBR1200.12 modular ramp

4ft wide ramp to clear heights up to 12in.



KBR1200.24 modular ramp

4ft wide ramp to clear heights up to 24in.

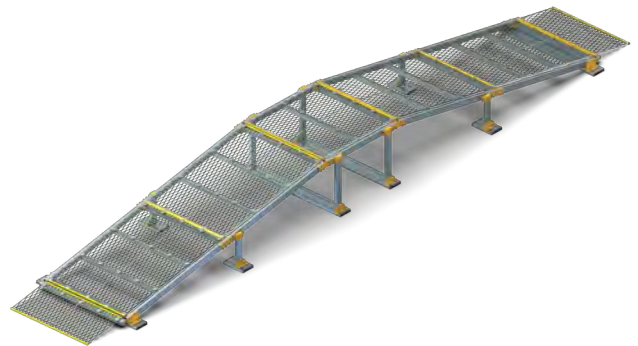

KBR1200.36 modular ramp

4ft wide ramp to clear heights up to 36in.

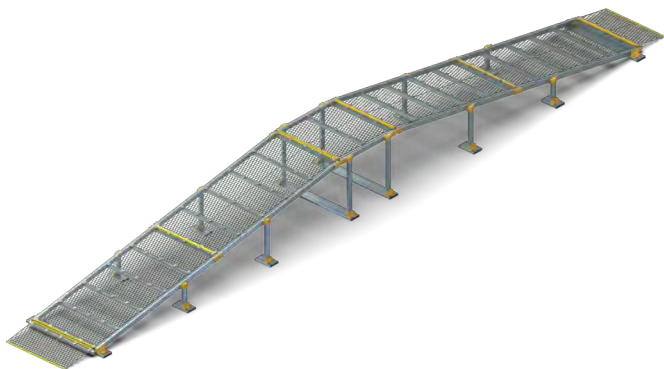

ROOF ACCESS HATCH SYSTEMS

Roof hatch system

Convenient, cost-efficient rooftop access, allowing for ladder and stair access to the roof.

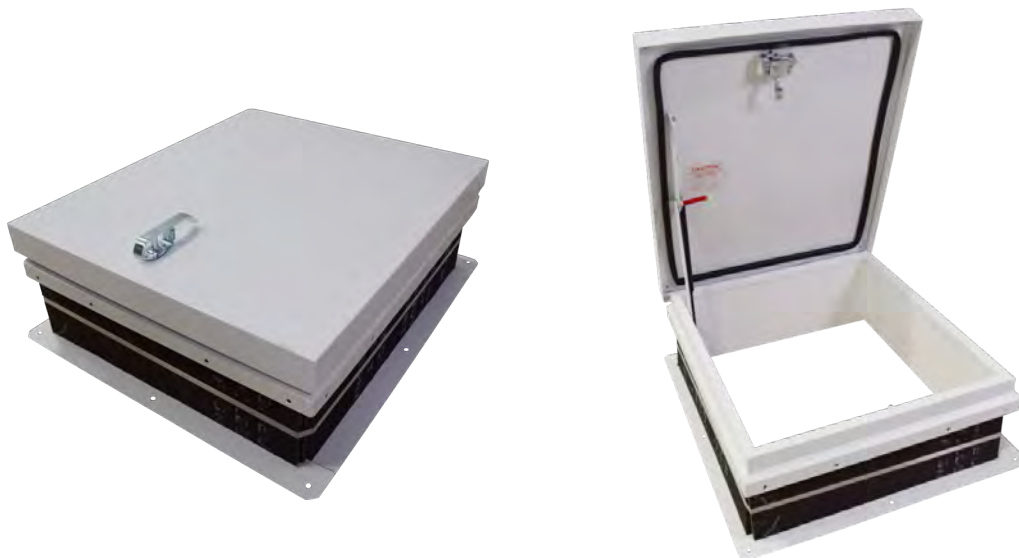

Roof hatch guardrail system

An innovative fixed railing system that assembles in minutes and provides permanent fall protection for hatch openings.



GUARDRAIL SYSTEMS OVERVIEW

GR31/GR33 internal & external wall mount guardrail

The highest level of passive safety for internal and external wall mounted applications.



GR32 metal roof mount guardrail

Designed for metal roofs including R panel and standing seam systems.

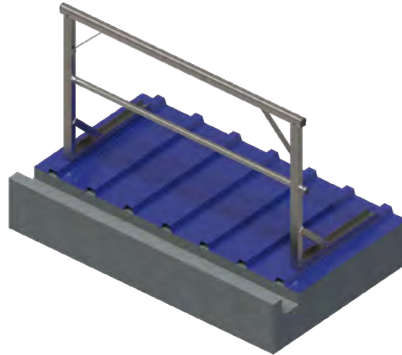

GR36 surface mount guardrail

For applications where an alternative to weighted bases is needed. Mounts into the roof deck, and approved by major membrane manufacturers to uphold warranty.

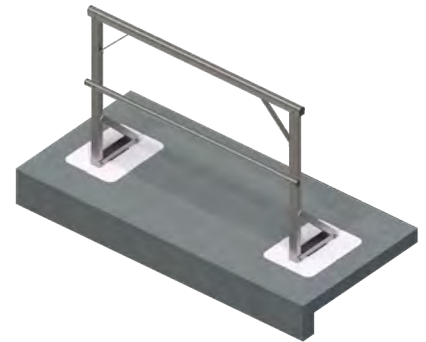

GR37.INT.IN non-penetrating in-line

Ideal for areas where space is limited

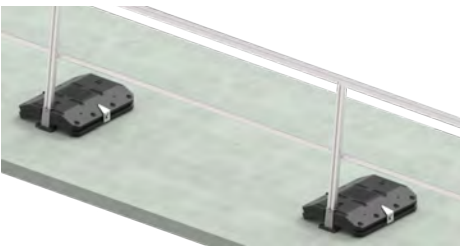

GR37.CW non-penetrating cantilevered

Standard configuration for GR37 orders

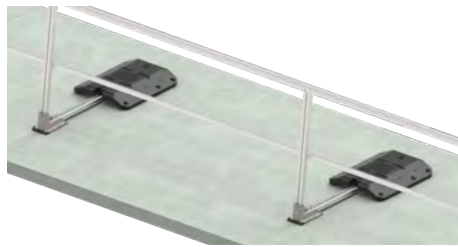

GR37.INT.HL non-penetrating high-load

Used in applications where higher loads are required (e.g. Cal OSHA)

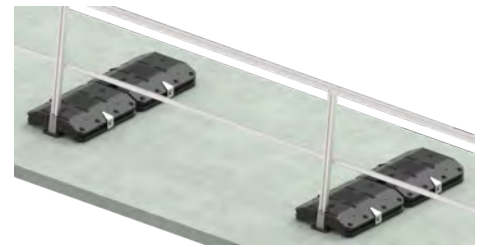

GRLP ladder protector

Boxed with our GW390A adjustable self-closing gate and ensures the user is an OSHA compliant distance from the unprotected edge.

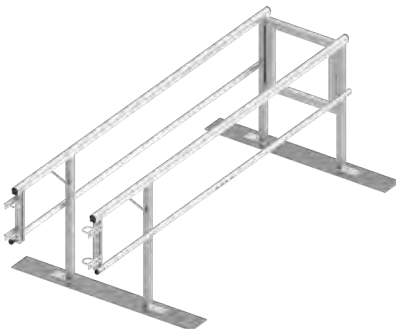

WARNING LINE SYSTEMS

WL31 metal roof mounted warning line

Designed for metal roofs including R panel and standing seam systems.

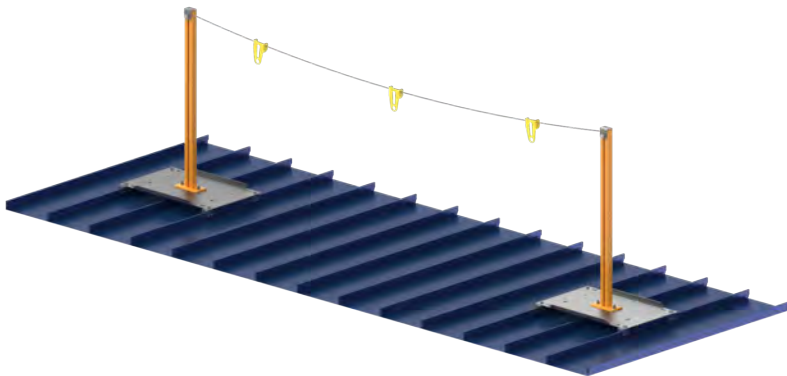

WL33 non-penetrating warning line

Designed for membrane and built-up roof systems. Bases are plastic coated concrete.

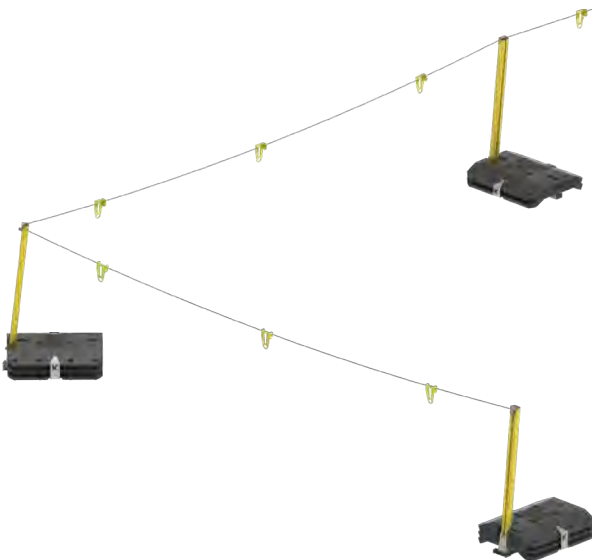

WALKWAY SYSTEMS

Flexible walkway matting (TPO/PVC)

A roll flat solution that is slip resistant, quick to install, keeps employees safe, and protects the integrity of the roof.

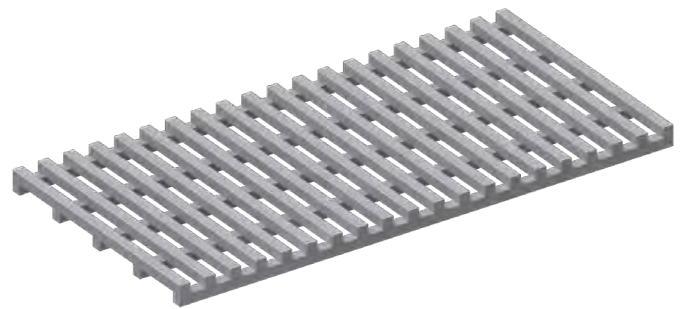
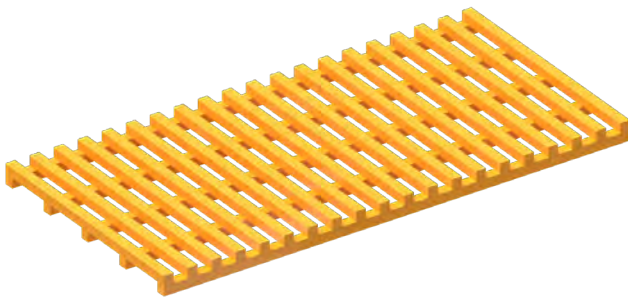

SEE OUR BOXED PRODUCTS IN ACTION

PHOTO GALLERY



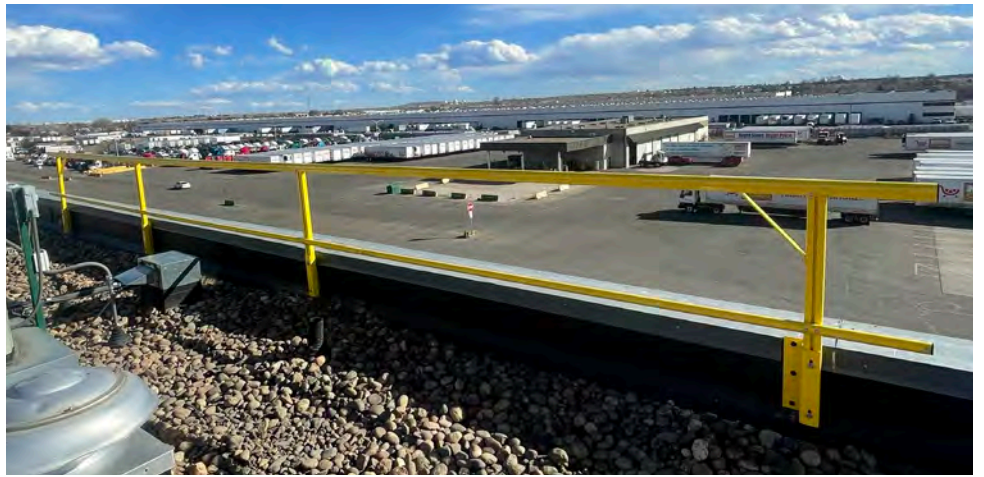

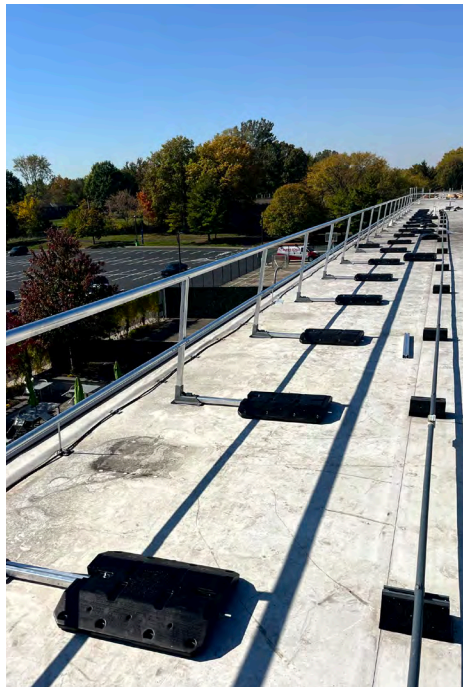



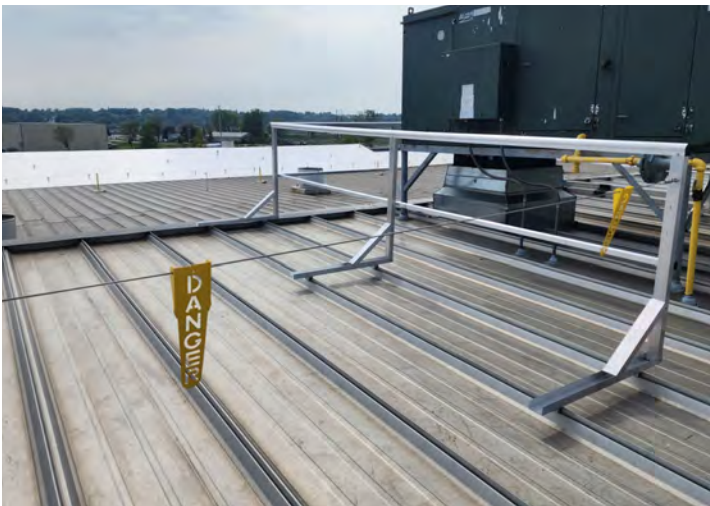
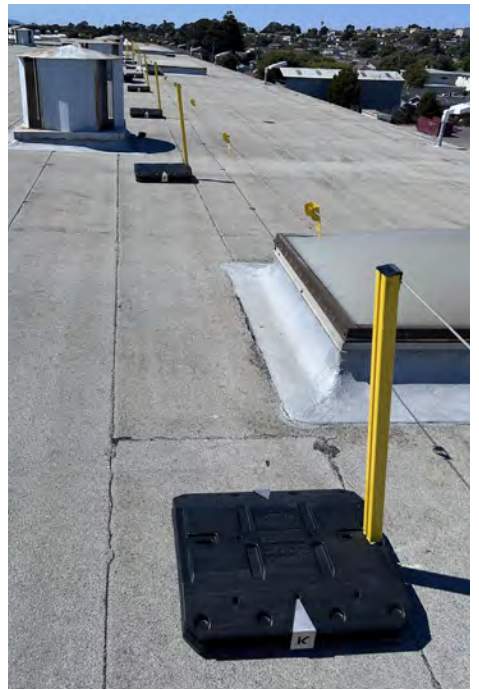
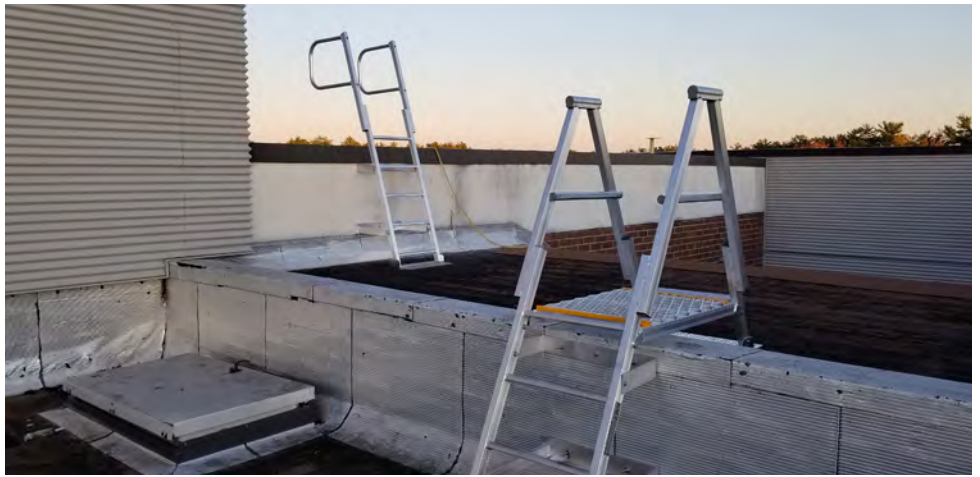

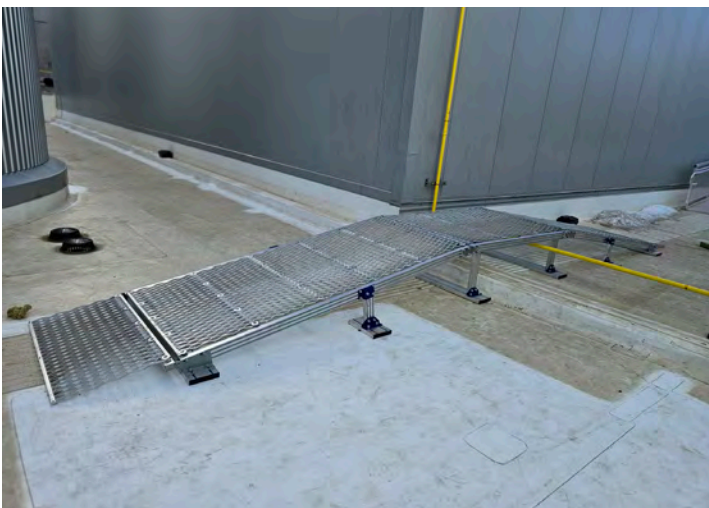
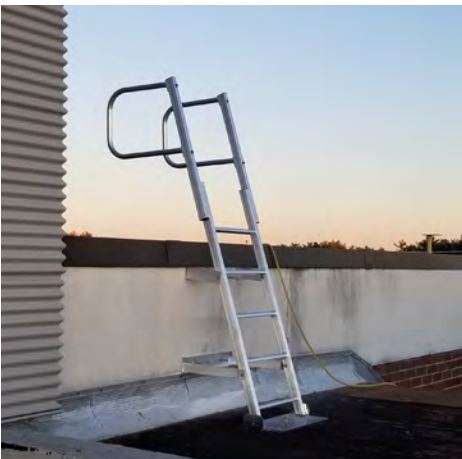





Request a quote
kattsafe.com/request-a-quote



View full product range
kattsafe.com/products



Product checklists
kattsafe.com/tools-and-calculators

Find all related products and resources on our website.
kattsafe.com

Kattsafe

Height access
and fall protection

5199 E 500 S, Suite 100
Whitestown, IN 46075
United States

888 637 7872
sales@kattsafe.com
kattsafe.com