



INSTALLATION MANUAL

BLINK SHASTA

Version 1.3



BLINK SHASTA

No part of the contents of this document may be reproduced or transmitted in any form or by any means without the express written permission of Blink. The contents of this document have been verified by the manufacturer to be consistent with the described components; however, inconsistencies sometimes occur. Such inconsistencies should be brought to the attention of a **Blink** representative. Changes to this manual may be made at any time without notice.

Disclaimer of Consequential Damages

Blink is not responsible for the use or application by any person of the materials in this manual. **Blink** is not responsible for damages, either direct or consequential, arising out of or relating to the use or application of these materials.

Certain sections of this manual are meant as a guide for professional electricians. The manual contains general guidelines and may not provide instructions for your specific situation. Do not attempt installation if you lack the knowledge and understanding required for the installation, otherwise personal injury and/or death as well as property damage or loss could occur.

Electricity is dangerous and can cause personal injury or death as well as other property loss or damage if not used or constructed properly. If you have any doubts whatsoever about performing the installation of the equipment, please do the smart thing and hire a licensed electrician to perform the work for you.

Never work with live voltage. Always disconnect the power source before working with electrical circuits.

When performing the installation, please read and follow this manual. Additionally, always follow your local electrical code and requirements which are specific to local areas.

Notice

Changes or modifications not expressly approved by the party responsible for compliance could void the user's authority to operate the equipment.

CONTENTS

1. SAFETY AND COMPLIANCE	6
1.1. GENERAL	7
1.2. STATEMENTS	7
2. PRODUCT OVERVIEW	9
2.1. PRODUCT SPECIFICATIONS.....	9
2.2. PRODUCT DIMENSIONS	11
2.2.1. Shasta 48/80 with Wall Mount Dimensions:.....	11
3. PLANNING AND DESIGN	11
3.1. ELECTRICAL REQUIREMENTS	11
3.1.1. 208 / 240 VAC SYSTEMS	12
3.1.2. DERATE SETTING & CIRCUIT BREAKER SIZING.....	13
3.2. COMMUNICATION REQUIREMENTS	14
3.3. NETWORK PLATFORM REQUIREMENTS	16
3.4. TOOLS REQUIRED FOR INSTALLATION	16
4. CHARGING STATION - PACKAGE CONTENTS	17
4.1. SHASTA 48 & 80	17
5. CHARGING STATION INSTALLATION	19
5.1. IMPORTANT SAFETY INSTRUCTIONS.....	19
5.2. WALL MOUNT INSTALLATION.....	20
5.2.1. Site Location.....	21
5.2.2. Preparing the Wall.....	21
5.2.3. Preparing the Holster.....	22
5.2.4. Wall Mount Bracket, Holster & Cable Hanger Installation	23
5.2.5. Head Unit Installation	23
5.3. CONNECTING INPUT WIRING AND OUTPUT CABLE	24
5.3.1. Connecting Input Wiring	25
5.3.2. Connecting Output Cable	25
5.4. DERATE SWITCH	27
6. CABLE MANAGEMENT SYSTEM (CMS) - PACKAGE CONTENTS	29
6.1. WALL MOUNT CMS PACKAGE CONTENTS	29

- 7. CABLE MANAGEMENT SYSTEM (CMS) INSTALLATION..... 30**
 - 7.1. WALL MOUNTING CMS..... 30
 - 7.1.1. Site Selection..... 30
 - 7.1.2. CMS Wall Mount Bracket Installation 30
 - 7.1.3. CMS Wall Mount Head Unit Installation..... 31
 - 7.1.4. CMS Cable Clamp Installation..... 31
- 8. COMMISSIONING AND ENERGIZATION 32**
 - 8.1. STATION COMMISSIONING..... 32
 - 8.2. INITIAL POWER-UP SEQUENCE 33
 - 8.3. WI-FI SETUP 33
 - 8.4. SIM CARD INSTALLATION 35
- 9. OPERATING INSTRUCTIONS..... 36**
 - 9.1. OPERATING PRECAUTIONS..... 36
 - 9.2. OPERATING INSTRUCTIONS..... 37
 - 9.2.1. Idle State 37
 - 9.2.1. User Authorization 38
 - 9.2.3. Charging 38
 - 9.2.4. Charging Complete..... 39
 - 9.3. TROUBLESHOOTING..... 40
 - 9.4. CUSTOMER SUPPORT 40
- 10. CLEANING AND MAINTENANCE..... 40**
- 11. WARRANTY 41**

Document Information

Name: Shasta 48/80 Installation Manual

Version: 1.2

Revision: 2/24/2026

Last Saved: 2/25/26 9:14:00 PM

File Name: Shasta 48_80 Installation Manual - v1.2 02242026.docx

Revision History

V	Date	Name	Title	Change Details
1.0	1/1	Bryan Cyr	Senior Quality Assurance Engineer	Initial version
1.1	2/11/26	Bryan Cyr	Senior Quality Assurance Engineer	Added front panel removal instructions (Section 5.3)
1.2	2/24/26	Bryan Cyr	Senior Quality Assurance Engineer	Modified graphics in Sections 8.3 and 8.4; added note about SIM card size in section 8.4

1. SAFETY AND COMPLIANCE

This document provides instructions to install the Blink Charging Station and should not be used for any other products. This product must be installed in accordance with the National Electrical Code (NEC), the Canadian Electrical Code (CEC) or any applicable local code.





Review this manual and consult a licensed contractor and/or electrician before installation to ensure compliance with local building practices, climate conditions, safety standards, and state and local codes.

The Blink Charging Station should be installed by a licensed contractor/ electrician and inspected by a qualified installer prior to initial use. Under no circumstances will compliance with the information in this manual relieve the user of responsibility to comply with all applicable codes and safety standards.

This document describes the most common installation and mounting methods. Contact Blink where it is not possible to perform an installation using the procedures provided in this document.

Blink is not responsible for damage that may occur or result from installations that are not described in this document. This document is not offered as a formal design document. All designs for the installation of this product are the sole responsibility of the appropriately licensed and/or certified installing contractor.

The following signs are used throughout the installation manual following ANSI Z535 Standard:

Sign	Intended Use
	Situation will result in serious injury or death
	Situation could result in serious injury or death
	Situation could result in moderate or minor injury
	Situations that at worst will result in property damage and will not result in physical injuries



MAKE SURE TO TURN OFF ALL BREAKERS BEFORE DOING ANY ELECTRICAL WORK!



DANGER

CAUTION

DO NOT USE THIS PRODUCT IF THERE IS ANY DAMAGE TO THE UNIT OR THE EV CHARGE CONNECTOR CABLE.

RISK OF ELECTRIC SHOCK. THIS PRODUCT CONTAINS NO USER SERVICEABLE PARTS.

ATTENTION

NE PAS UTILISER CE PRODUIT SI L'APPAREIL OU LE CABLE VE EST ENDOMMAGE.

RISQUE DE CHOC ELECTRIQUE. NE CONTIENT AUCUNE PIECE A REPARER PAR L'UTILISATEUR.



WARNING / NOTICE

AUTOMATIC RESET FEATURE IS PROVIDED.



WARNING / AVERTISSEMENT

FOR USE WITH ELECTRIC VEHICLES

POUR UTILISATION AVEC DES VEHICULES ELECTRIQUES

WARNING

ONLY FOR USE WITH VEHICLES THAT DO NOT REQUIRE VENTILATION. AVOID RISK OF FIRE OR ELECTRICAL SHOCK, DO NOT USE THIS DEVICE WITH AN EXTENSION CORD.

AVERTISSEMENT

UNIQUEMENT POUR UTILISATION AVEC DES VEHICULES NE NECESSITANT PAS DE VENTILATION POUR EVITER TOUT RISQUE D'INCENDIE OU DE CHOC ELECTRIQUE, NE PAS UTILISER CET APPAREIL AVEC UNE RALLONGE.

1.1. GENERAL

The Blink Station is grounded through a dedicated conductor to the ground connection at the power distribution panel. This equipment has been tested and found to comply with the limits for a Class A digital device, pursuant to Part 15 of the FCC rules. These limits are designed to provide reasonable protection against harmful interference when the equipment is operated in a commercial environment.

NOTICE

The equipment generates, uses, and can radiate radio frequency energy and, if not installed and used in accordance with the instruction manual, may cause harmful interference to radio communications.

1.2. STATEMENTS

Reasonable effort has been made to ensure that the specifications and other information in this manual are accurate and complete at the time of publication. However, specifications and other information in this manual are subject to change at any time without prior notice.

NOTICE

Use of the Blink Charging Station in a manner not intended or any modification not approved by the manufacturer will void the limited warranty. Other than the limited product warranty provided by Blink, this manual and the Blink Inc. products are provided "AS IS," and Blink Inc. expressly disclaim all implied warranties, including any warranty of design, merchantability, and fitness for a particular purposes and non-infringement, to the maximum extent permitted by law.

NOTICE

IN NO EVENT SHALL BLINK INC. OR ITS AUTHORIZED DISTRIBUTORS BE LIABLE FOR ANY INDIRECT, INCIDENTAL, SPECIAL, PUNITIVE, OR CONSEQUENTIAL DAMAGES, INCLUDING WITHOUT LIMITATION, LOST PROFITS, LOST DATA, LOSS OF USE, COST OF COVER, OR LOSS OR DAMAGE TO THE BLINK CHARGING STATION ARISING OUT OF OR RELATING TO THE USE OR INABILITY TO USE THIS MANUAL, OR RELATED PRODUCT, EVEN IF BLINK OR ITS AUTHORIZED DISTRIBUTORS HAVE BEEN ADVISED OF THE POSSIBILITY OF SUCH DAMAGES.

All products or services mentioned are the trademarks, service marks, registered trademarks, or registered service marks of their respective owners. This material is protected by the copyright laws of the United States and other countries. It may not be modified, reproduced, or distributed without the prior, express written consent of Blink Network, LLC.

2. PRODUCT OVERVIEW

2.1. PRODUCT SPECIFICATIONS

ELECTRICAL SPECIFICATION – AC OUTPUT	
Number of Ports	One
Output Current	Shasta 80 - Configurable up to 80A Shasta 48 - Configurable up to 48A
Hardware Output Current Derating	Yes
Power	Shasta 80 - Up to 19.2 kW @ 240 VAC Shasta 48 - Up to 11.52 kW @ 240 VAC
Energy Metering Accuracy	+/- 1%
Charging Connector	J1772 or NACS (SAE J3400)
ELECTRICAL SPECIFICATION – AC INPUT	
Input Connector	Hardwired
Voltage	208-240 VAC, 50-60Hz
Service Panel Breaker	Shasta 80 - 1 x 100A Max Shasta 48 - 1 x 60A Max (Depending On Output Configuration; see section 3.1.2)
Power Connection	Line 1, Line 2, and Ground (No Neutral)
Input Wire Gauge	Line1, Line 2 – 1/0 - 8 AWG Ground – 6 - 16 AWG
Input Electrical Conduit	1” Trade Size Max
SAFETY SPECIFICATION	
Ground Fault Circuit Interrupt	15-20mA
Automatic Plug- Out Detection	Power Terminated Per SAE J1772 Specifications
Over Voltage Category	OVC III
Surge Protection	6kV @ 3,000A
Other	Weld Detection, Overvoltage, Overcurrent, Overtemperature
FUNCTIONAL SPECIFICATION	
Interfaces	Ethernet, W-Fi, Cellular 4G LTE, WCDMA
Communication	OCPP 1.6 Compliant ISO15118-2 / ISO15118-20 (Hardware Ready)
Remote Management	Over-the-Air (OTA) Firmware Updates

Edge Intelligence	Cable Tamper Alert Enclosure Open Alert Multi Point Temperature & Humidity Monitoring Charging Functions Available During Communication Outage
USER INTERACTION SPECIFICATION	
Display	7" Touch Screen LCD
Authentication	RFID: ISO14443A/B (Mifare Classic)
Payment Methods	RFID card, Mobile app, or Credit card via IVR
ENVIRONMENTAL SPECIFICATION	
Enclosure	Indoor & Outdoor, IP66 NEMA 3R or greater
Operating Humidity	Up to 95% Non-Condensing
Operating Temperature	-40C to +50C (-40F to 122F)
Storage Temperature	-40C to +60C (-40F to 140F)
Operating Altitude	<=9,840 ft
MECHANICAL SPECIFICATION	
Dimensions (H x W x D)	17.4" x 8.5" x 3.8"
Approximate Weights	Charger: 22 lbs., Wall mount: 1.1 lbs.
Mounting Option	Wall Mount (contact Blink for alternate mounting options)
Cable Length	25 ft
REGULATION	
Safety	UL 2594, UL 2231-1, UL 2231-2, UL1998 Certified
Energy Metering	NIST HB 44 Compliant
EMI	FCC Part 15 Class A Compliant
Energy Efficiency	Energy Star Certified (Pending)
Compliance	National Type Evaluation Program (NTEP) (Pending)

2.2. PRODUCT DIMENSIONS

2.2.1. SHASTA 48/80 WITH WALL MOUNT DIMENSIONS:



Fig. 1 – Shasta 48/80 charger

3. PLANNING AND DESIGN

3.1. ELECTRICAL REQUIREMENTS

⚠ WARNING

Blink EV charging stations require a solidly grounded electrical system with the presence of a main bonding jumper or system bonding jumper. Ungrounded sources or impedance grounded sources of any type (resistor/reactor) are not suitable for Blink EV charging stations.

⚠ WARNING

Improper connection of the equipment-grounding conductor is able to result in a risk of electric shock. Check with a qualified electrician or serviceman if you are in doubt as to whether the product is properly grounded. Do not modify the plug provided with the product – if it will not fit the outlet, have a proper outlet installed by a qualified electrician.

⚠ WARNING

To reduce the risk of fire, electric shock, or injury to persons:

- Read all the instructions carefully before installing & using the product.
- Do not use this device if it is damaged, has visible cracks, or is missing parts.
- Connect only to properly grounded outlets and circuits in accordance with all local electrical codes.
- Do not install or use the equipment near flammable materials, vapors, or in wet environment unless rated for such use.
- Installation & Servicing should only be performed by qualified personnel.
- Disconnect the power at the breaker panel before servicing or cleaning the unit.

3.1.1. 208 / 240 VAC SYSTEMS

The **Shasta 48** and **Shasta 80** charging stations require 240-volt (phase to phase) or 208-volt (phase to phase) input with an equipment grounding conductor.

A Neutral conductor is not connected to the charger itself, but the Neutral or Center-Tap connection on the service transformer must be connected to Earth Ground.

The Shasta 48 and Shasta 80 charging stations have internal GFCI protection; therefore, GFCI breakers are not needed unless required by local electrical code.

Connect the Shasta 48 or Shasta 80 Charging Stations to any one of the power sources below:

- 240 VAC three phase, Delta system, Center tap grounded
- 208 VAC three phase, Wye system, Bonded neutral
- 240 VAC single phase, Bonded neutral

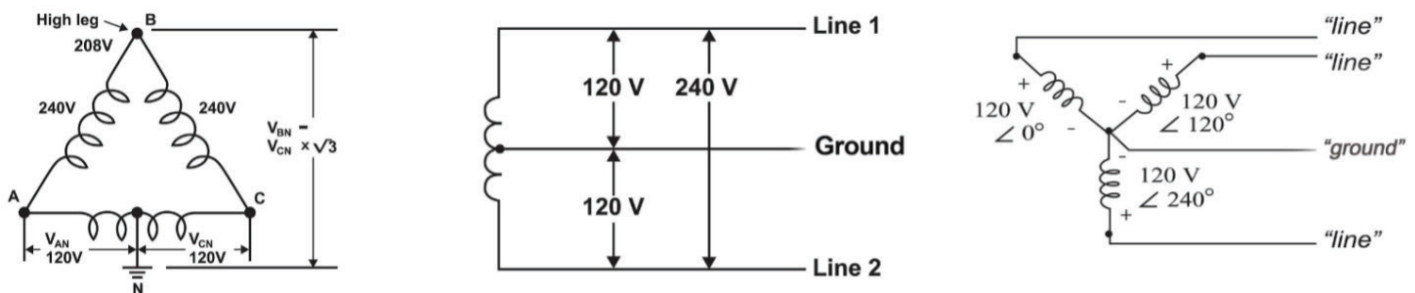

Fig. 2 – Acceptable transformer configurations

In a Wye system, connect the charging stations to any of the two lines. Do not use the system if it has a floating ground.

In a Delta system, connect the charging station only to a center-tapped grounded transformer as shown above. Connect the station to the side where ground is bonded (Line A and Line C above). This allows

voltages to remain constant regardless of other loads on the system.

Please do not connect to other types of Delta transformers, as indicated below.

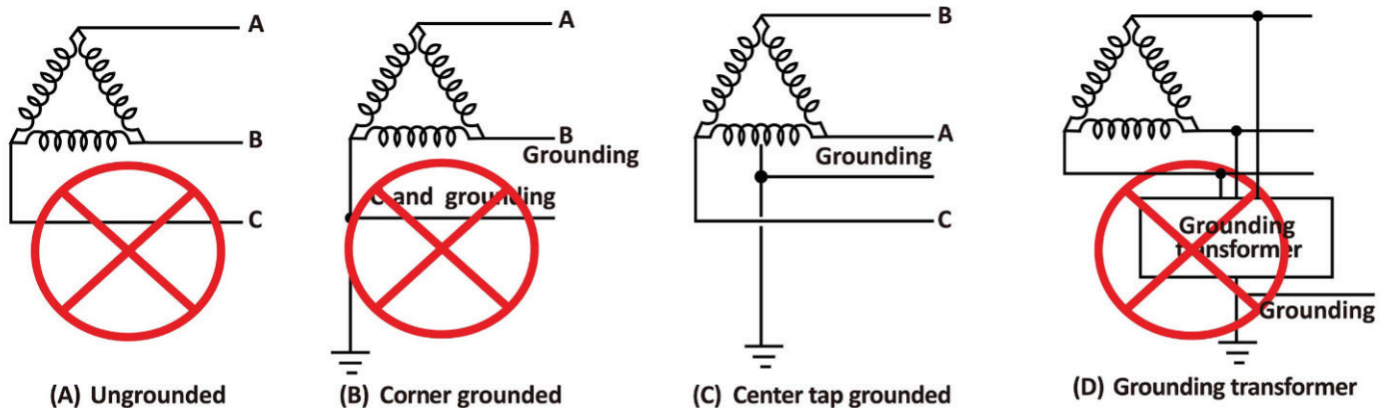

Fig. 3 – Unacceptable Delta transformer configurations

3.1.2. DERATE SETTING & CIRCUIT BREAKER SIZING

⚠ WARNING

Each Blink EV charging station is listed and labeled through Nationally Recognized Testing Laboratory compliance testing at the maximum or ‘full rated’ output. Each station is capable of continuous full rated output up to its labeled rating or modified default output configurations. In accordance with NEC Article 625, circuit breakers should be sized at 125% of the station’s maximum amperage output.

The Shasta 48 and Shasta 80 charging stations are equipped with a “Derate” switch which will reduce the charger’s maximum output current. The following table summarizes the circuit breaker size, station output amperage, and corresponding Derate switch settings. For instructions on accessing and adjusting the Derate switch, see section 5.4.

SHASTA 80 DERATE SETTINGS		
CIRCUIT BREAKER SIZE	MAXIMUM OUTPUT	DERATE SWITCH SETTING
100A	80A	7
80A	64A	6
70A	56A	5
60A	48A	4
50A	40A	3
40A	32A	2
30A	24A	1
20A	16A	0

Table 1 – Circuit breaker size vs charger output configuration for Shasta 80

SHASTA 48 DERATE SETTINGS		
CIRCUIT BREAKER SIZE	MAXIMUM OUTPUT	DERATE SWITCH SETTING
60A	48A	7
		6
		5
		4
50A	40A	3
40A	32A	2
30A	24A	1
20A	16A	0

Table 2 – Circuit breaker size vs charger output configuration for Shasta 48

3.2. COMMUNICATION REQUIREMENTS

- CAUTION**

The equipment generates, uses, and can radiate radio frequency energy and, if not installed and used in accordance with the instruction manual, may cause harmful interference to radio communications.

- NOTICE**

This equipment has been tested and found to comply with the limits for a Class A digital device, pursuant to Part 15 of the FCC rules. These limits are designed to provide reasonable protection against harmful interference when the equipment is operated in a commercial environment.

- The Shasta 48 and Shasta 80 EV charging stations require cellular, Wi-Fi, or ethernet connectivity to function properly. It is recommended to check cellular and Wi-Fi signal strength before charger installation.
- To enable cellular connectivity, please reference the following cellular carriers and minimum operational signal requirement at each EV charging station location:

ATT or T-Mobile	4G LTE	Band 2 Band 4 Band 5 Band 12 Band 13
Verizon	4G LTE	Band 4 Band 13

Table 3 – Cellular carriers and bands

- Stations are shipped with a SIM card for one of the above carriers. Client must verify signal levels for all carriers and notify Blink prior to order shipment if a specific carrier is required.

- Recommended cellular signal strength values are RSRP \geq -80 dBm and RSRQ \geq -10 dB. See the table below for reference:

Signal Strength	RSRP (dBm)	RSRQ (dB)
Excellent	\geq -80	\geq -10
Good	-80 to -90	-10 to -15
Fair	-90 to -100	-15 to -20

Table 4 – Cellular signal strength requirements

- For instructions to install the SIM card, see section 8.4
- For instructions to set up Wi-Fi communication, see section 8.3
- Ethernet wiring is connected from the bottom of the head unit (see below).

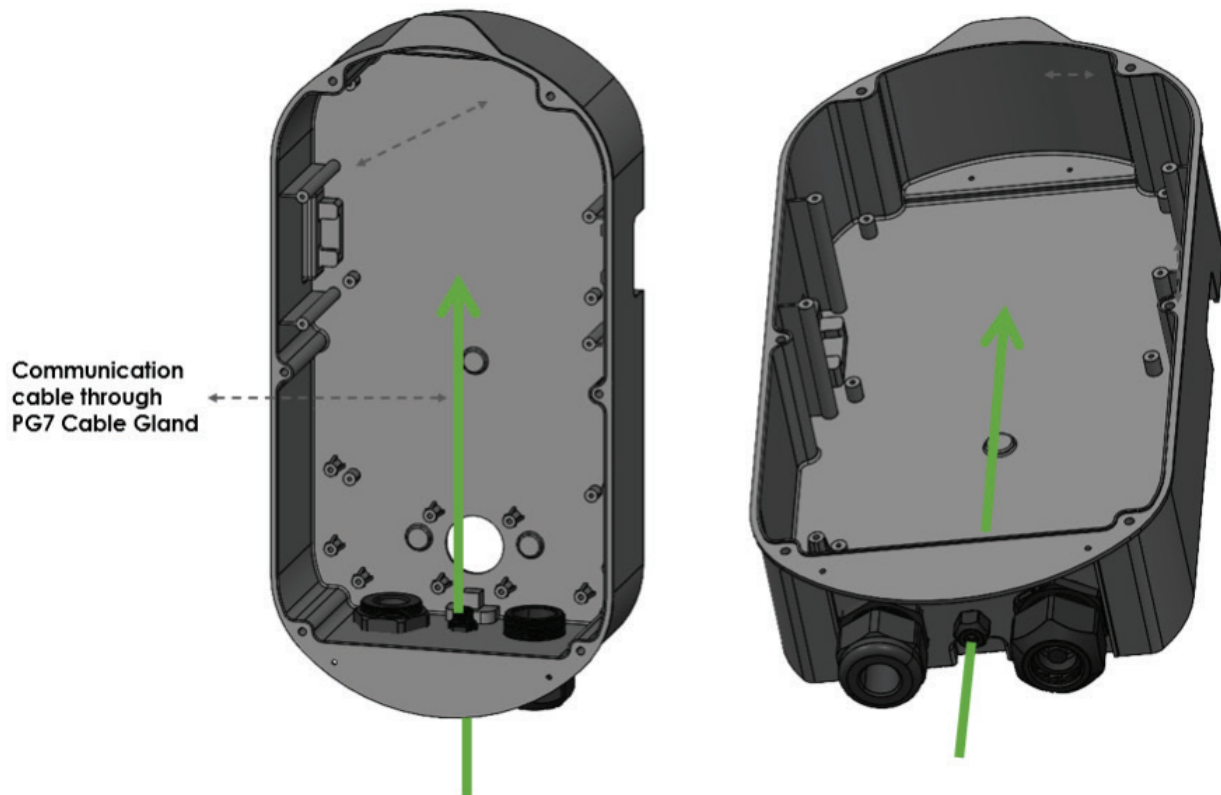

Fig. 4 – Ethernet cable penetration

- When the station is connected via an Ethernet cable, no additional setup is required.
- **NOTICE**
Ethernet wiring must be run in a separate conduit from the AC input power wires to avoid interference.

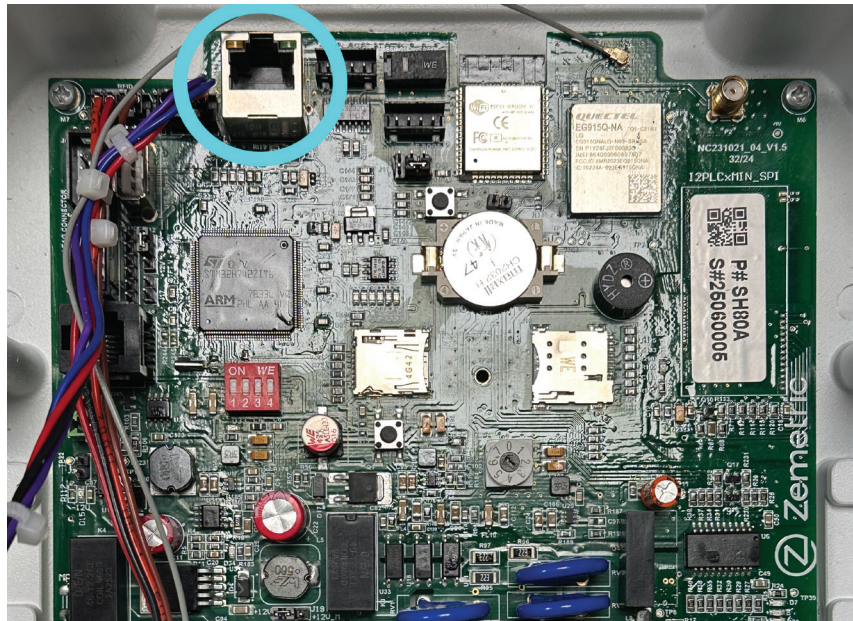

Fig. 5 – Ethernet port location

3.3. NETWORK PLATFORM REQUIREMENTS

To enable modified output configurations or load management configurations, Blink must be notified during station commissioning. Failure to do so may result in nuisance breaker tripping and/or system damage. Refer to the Station Commissioning section of this manual (Section 8) for details.

3.4. TOOLS REQUIRED FOR INSTALLATION

Note: Does not include tools required for installation of electrical conduit

#	Tool	Notes
1	Metric Allen Keys	2.5mm, 3mm, 4mm, 5mm
2	Security Torx bit	T25, T30
3	Phillips screwdriver	
4	Torque Wrench	Required for Input/Output AC terminal connections (0 – 11Nm) & Ground terminal connection (0 – 3.95Nm)
5	Wire Stripping tool	
6	Wire Crimping tool	For 8 AWG and 6 AWG ferrules (Shasta 48), 2 AWG ferrules (Shasta 80)
7	Masonry Drill Bit(s) & Driver	

Table 5 – Tools Required for Installation

4. CHARGING STATION - PACKAGE CONTENTS

4.1. SHASTA 48 & 80

Part	Qty	Image
Shasta 48/80 Charging Station Head Unit	1	 A black and grey charging station head unit. It features a central screen displaying the 'blink' logo and a wireless charging symbol below it. The 'blink' logo is also printed at the bottom of the unit.
Wall Mounting Bracket	1	 A black T-shaped wall mounting bracket with a circular hole at the bottom for a screw.
Holster Bracket Assembly with L-Bracket	1	 A black rectangular holster bracket assembly with a recessed area for the charging station.
Cable Hanger	1	 A black L-shaped cable hanger bracket with a hook for holding a charging cable.
J1772 Holster (J1772 model only)	1	 A black J1772 holster, which is a circular protective cover for the charging station's charging port.

NACS Holster (NACS model only)	1	
Wall Mounting Screws with Nylon Plug (No 10 2.5")	11	
Holster Mounting Screws - Socket Head Hex (M4x8mm; pre-assembled)	4	
Wall Mount Bracket Screws - Button Head T25 Security Torx (M4x12mm; pre-assembled)	5	
Holster Bracket Mounting Screws – Socket Head Hex (M6x20mm; Pedestal Installation only)	2	
Holster Plate Mounting Screws – Button Head Hex (M6x20mm; Pedestal Installation only)	4	
Input AC Wire Ferrite	1	
Cable Clamp (2 pcs)	2	
Cable Clamp Screws – Button Head Hex (M4x25mm)	4	





6 AWG Ferrule (use in Shasta 48 only)	2	
2 AWG Ferrule (use in Shasta 80 only)	2	
8 AWG Ferrule	1	
PG-29 Cable Gland Insert (for 48A NACS cable)	1	
PG-29 Cable Gland Plug	1	
Product Postcard	1	

Table 6 – Charger box contents

5. CHARGING STATION INSTALLATION

5.1. IMPORTANT SAFETY INSTRUCTIONS

⚠ WARNING

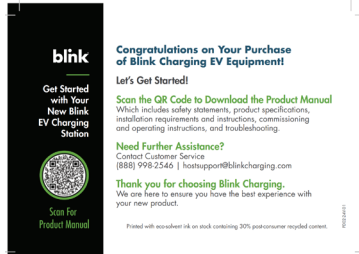
Improper connection of the equipment-grounding conductor is able to result in a risk of electric shock. Check with a qualified electrician or serviceman if you are in doubt as to whether the product is properly grounded. Do not modify the plug provided with the product – if it will not fit the outlet, have a proper outlet installed by a qualified electrician.

⚠ WARNING

To reduce the risk of fire, electric shock, or injury to persons:

- Read all the instructions carefully before installing & using the product.
- Do not use this device if it is damaged, has visible cracks, or is missing parts.
- Connect only to properly grounded outlets and circuits in accordance with all local electrical codes.
- Do not install or use the equipment near flammable materials, vapors, or in wet environment unless rated for such use.
- Installation & Servicing should only be performed by qualified personnel.
- Disconnect the power at the breaker panel before servicing or cleaning the unit.

5.2. WALL MOUNT INSTALLATION



Fig. 6 – Shasta 48 & 80 Wall Mount Installation

5.2.1. SITE LOCATION

The charging station should be positioned such that the distance between the charging station and electric vehicle is sufficient to minimize the likelihood of damage (suggested min. 3 ft). Two alternatives are illustrated below:

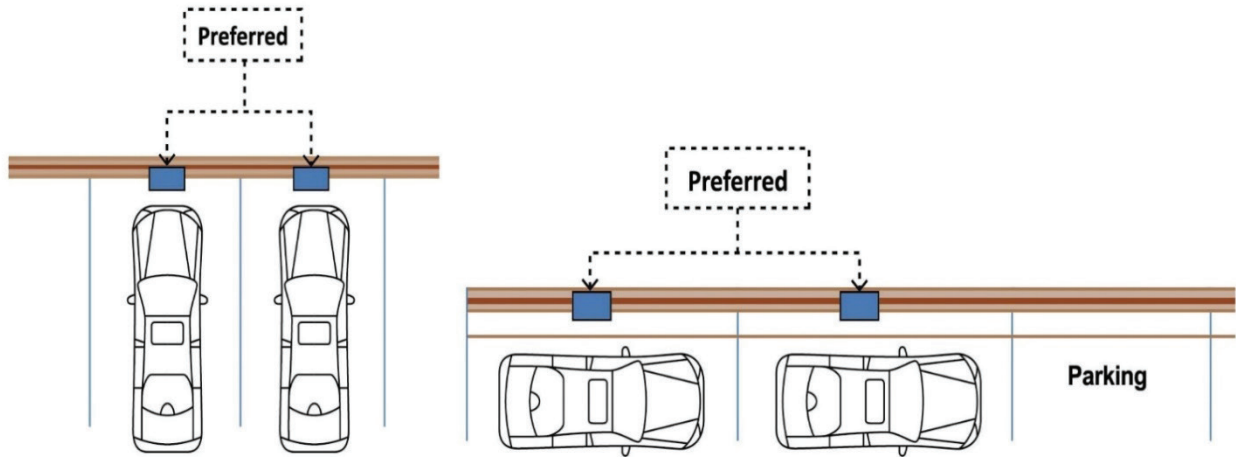

Fig. 7 – Site location recommendations

5.2.2. PREPARING THE WALL

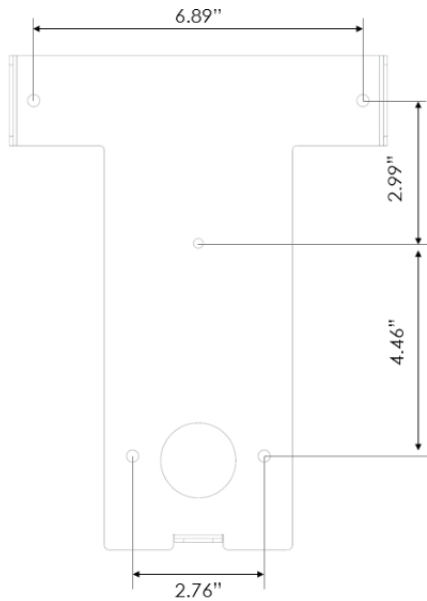

Fig. 8 – Wall Mount bracket template

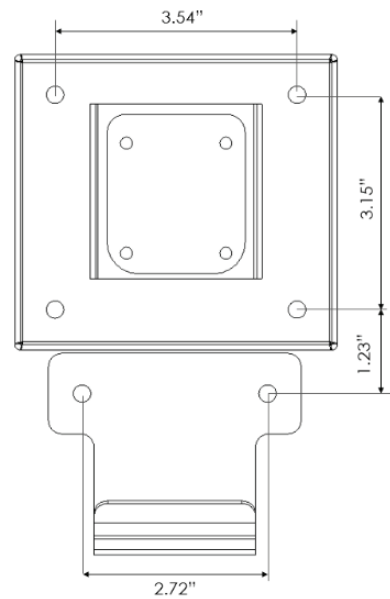

Fig. 9 – Cable Hanger bracket template

- At the selected location, install the wall mount such that the top of the bracket is at a height of 46 inches (Check local codes).
- The equipment should be installed at least 20 inches above the floor.
- Ensure the wall mount bracket is in an upright position and level.
- Mark locations for the bolts before drilling mounting holes.

- If the wall is made of solid concrete or brick, use the provided anchor bolts to secure the wall-mount to the wall. For walls other than concrete, use fasteners appropriate for the material.
- Electrical input wiring can enter the charger head unit either from the rear (through the 1-3/8” hole on the back of the head unit) or from the bottom. If the input wiring enters the from the rear (through the wall), mark and drill the conduit penetration location before installing the wall mount.
- If the electrical conduit is run on the outside of the wall, use the 1-3/8” hole on the bottom of the charger head unit as the entry point (maximum conduit size 1”).
- Ensure at least 18” (+ wall thickness for rear entry) of wire extends out of the conduit.

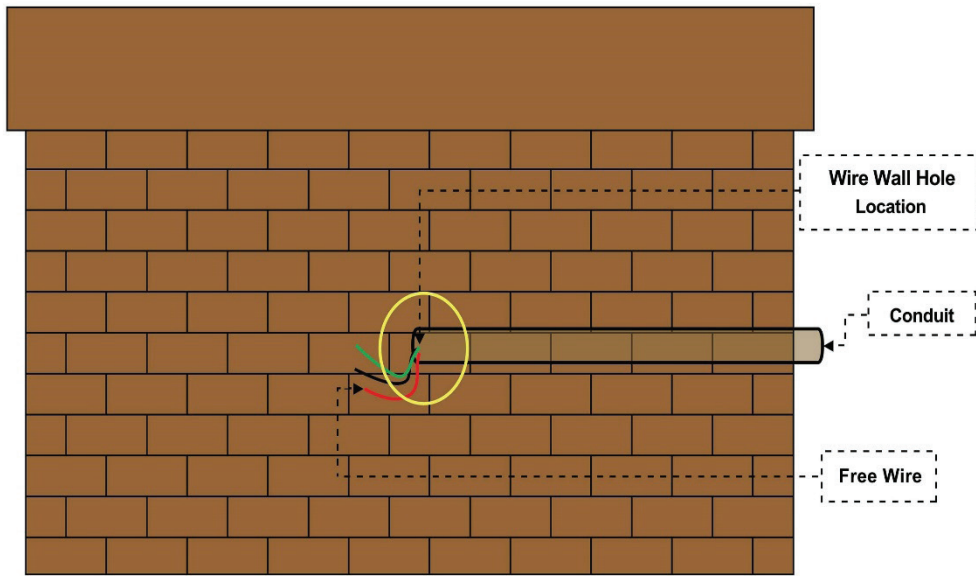

Fig. 10 – Wall preparation

5.2.3. PREPARING THE HOLSTER

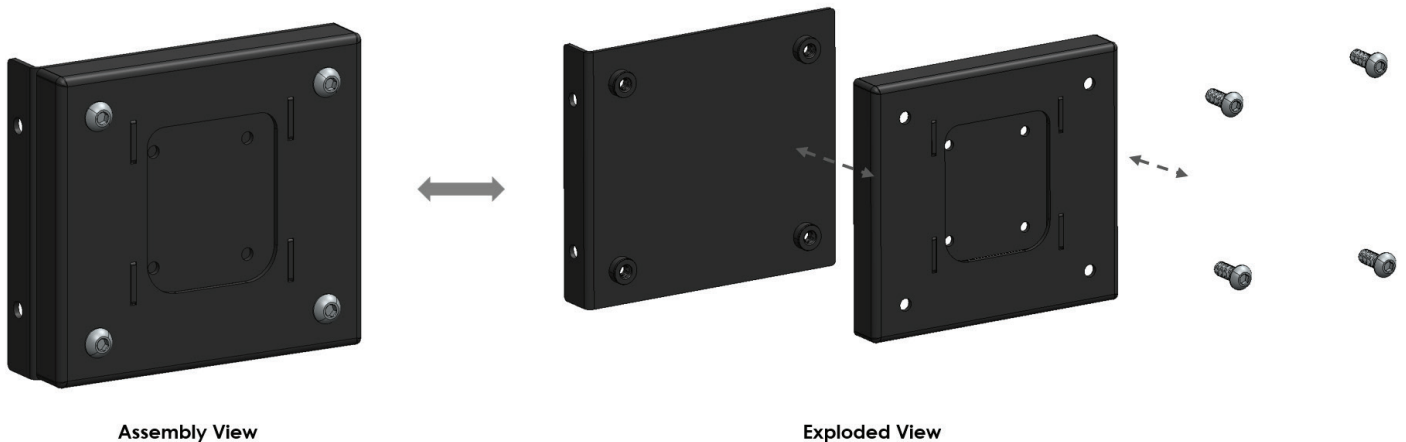

Fig. 11 – Holster Preparation

- Before proceeding with the wall mounting of the holster, detach the L-Bracket from the Holster assembly by removing 4 screws (the L-bracket is only required for pedestal installation).

5.2.4. WALL MOUNT BRACKET, HOLSTER & CABLE HANGER INSTALLATION

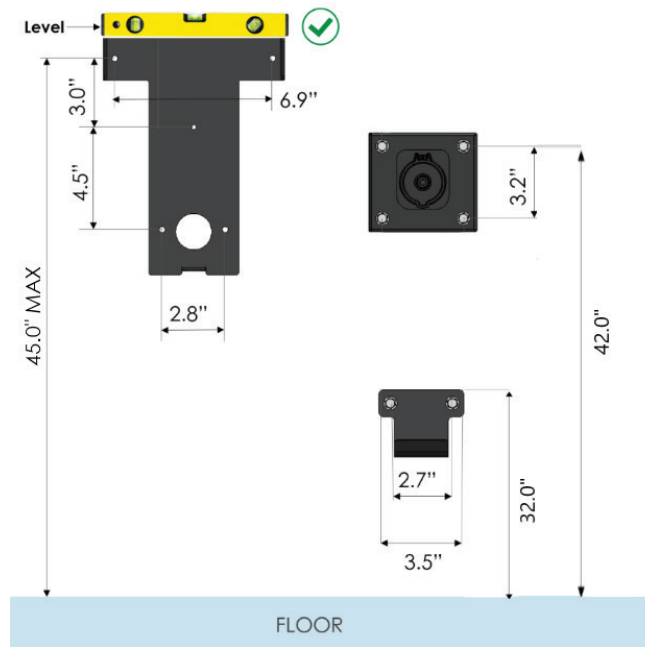

Fig. 12 – Wall mount dimensions

- Secure the wall mount bracket with the provided anchor bolts (if concrete or brick wall), or with appropriate fasteners (for other material).
- Secure the cable hanger and holster bracket using the provided anchors as shown in the above graphic.
- Install the appropriate holster (J1772 or NACS) to the holster wall bracket using the provided M4x8mm screws.

5.2.5. HEAD UNIT INSTALLATION



Fig. 13 – Head Unit mounting to Wall Bracket

⚠ CAUTION

- Refer to General Requirements section for station weights.
- Carefully place the charging station head unit on top of the wall mount bracket as shown in the illustration.
- Align the guide poles in the wall mount bracket with the base of the head unit.
- Secure the charging station head unit to the wall bracket with the 5 mounting screws (M4x12mm - two from right and left side and one from bottom side).
- Ensure that the charging station is plumb using a level. Check that the head unit is now securely fastened to the wall mount.

5.3. CONNECTING INPUT WIRING AND OUTPUT CABLE

⚠ WARNING

VERIFY ALL CONDUCTORS ARE DE-ENERGIZED BEFORE PROCEEDING.

Refer to the wire color codes and strictly adhere to this convention while connecting the charging station and electrical supply wires. Incorrect wiring can lead to an electrical hazard.

⚠ WARNING

Improper connection of the equipment-grounding conductor is able to result in a risk of electric shock. Check with a qualified electrician or serviceman if you are in doubt as to whether the product is properly grounded. Do not modify the plug provided with the product – if it will not fit the outlet, have a proper outlet installed by a qualified electrician.

NOTICE

Note about removing the charger's front cover: After removing the charger's front cover, it is recommended to disconnect the RFID, TFT display, and cellular antenna connectors from the main PCB. Use care and caution when disconnecting and re-connecting the cellular antenna.

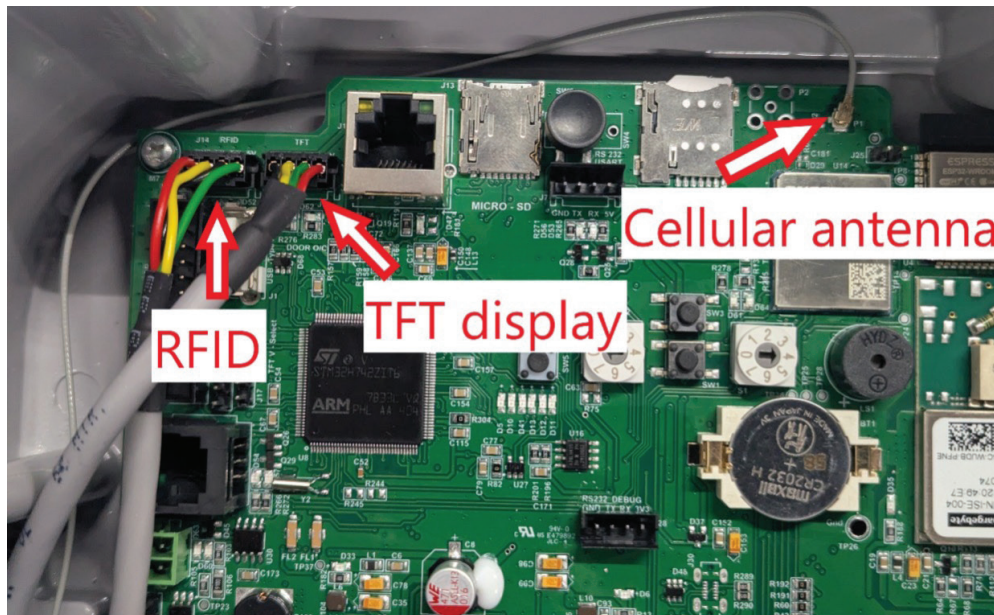

Fig. 14 – RFID, TFT, and cellular connections

5.3.1. CONNECTING INPUT WIRING

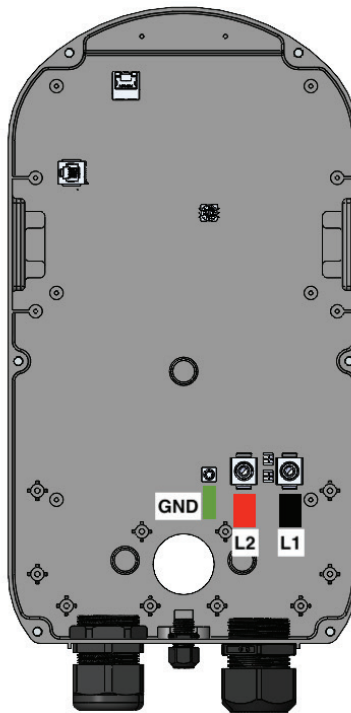

Fig. 15 – AC input wire connections

- If necessary, remove the charger’s front cover.
- If electrical input wiring is run through the bottom of the head unit, secure the conduit before connecting the wiring inside the charger.
- Locate the AC input terminals for L1, L2, and GND.
- Cut the AC input conductors to length and strip insulation back 12mm (1/2”)
- Crimp the L1 and L2 input conductors with the supplied 2 or 6 AWG ferrules
- Crimp the Ground input conductor with the supplied 8 AWG ferrule
- Pass the L1, L2, and Ground input conductors through the provided ferrite
- Insert the Ground conductor into the GND input terminal (Torque = 3.95 Nm)
- 208/240 VAC installation – insert the two-phase conductors into the L1 and L2 input terminals (Torque = 11 Nm)

5.3.2. CONNECTING OUTPUT CABLE

NOTICE

The Shasta charger is shipped with either a 48-Amp or an 80-Amp charging cable depending on model/features. Installing a 48-Amp cable on an 80-Amp charger may result in damage to the equipment.

- If necessary, remove the charger’s front cover.
- If installing an NACS cable on the Shasta 48, install the cable gland insert into the PG29 cable gland.
- Insert the output cable into the PG29 cable gland so that the cable jacket extends approximately 1” past the cable gland nut.
- Tighten the PG29 cable gland nut to secure the cable.

- Install the 2-piece cable clamp and screws (2.5mm hex).
- Locate the output terminals for L1, L2, GND, and low-voltage connections.
- Insert the GND conductor into the GND output terminal (Torque = 3.95 Nm) and the L1 and L2 conductors into the respective output terminals (Torque = 11 Nm).
- Insert the low-voltage conductors into the low-voltage terminal block as shown.
- Replace the charger's front cover.

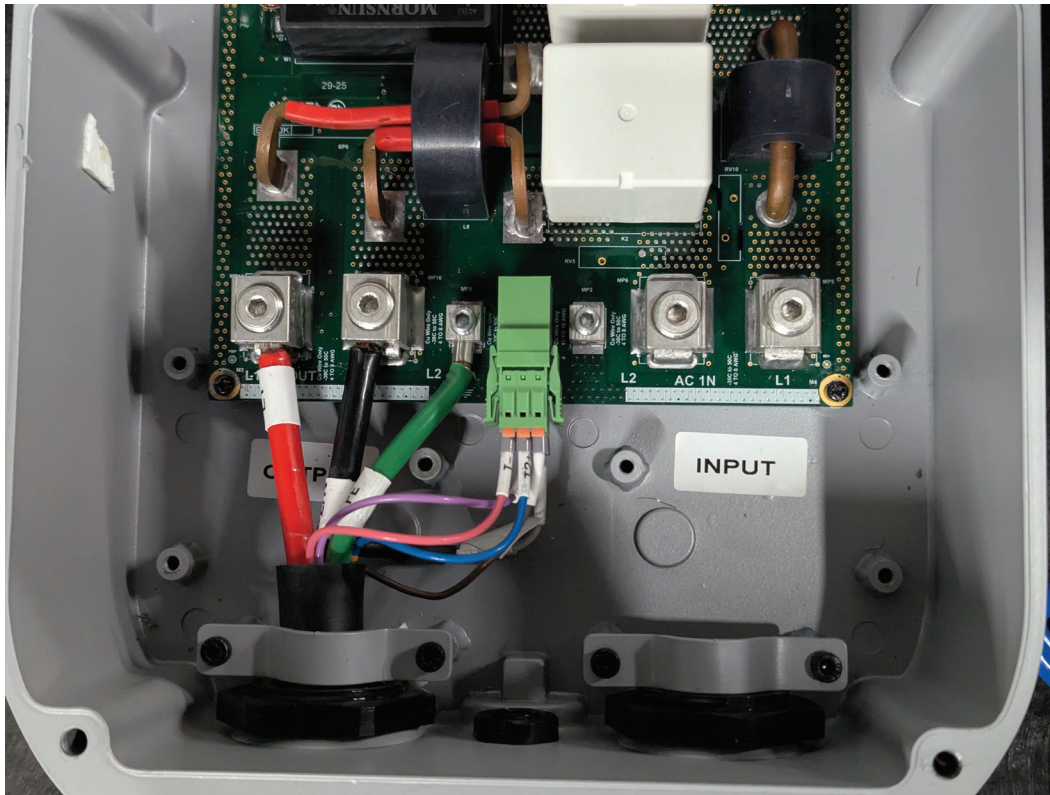
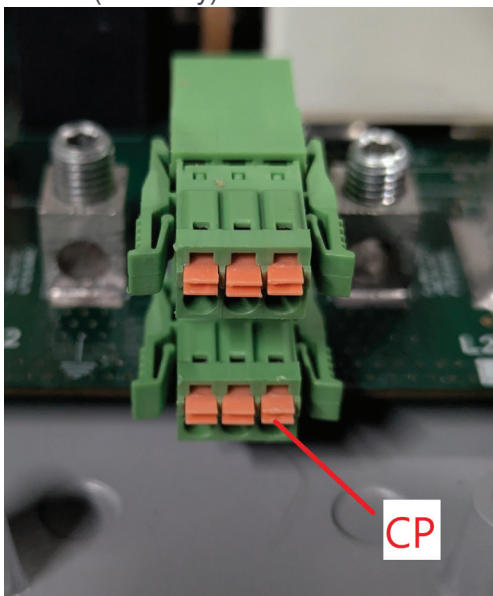

Fig. 16 – Output cable connections

J1772 (CP Only):



NACS:

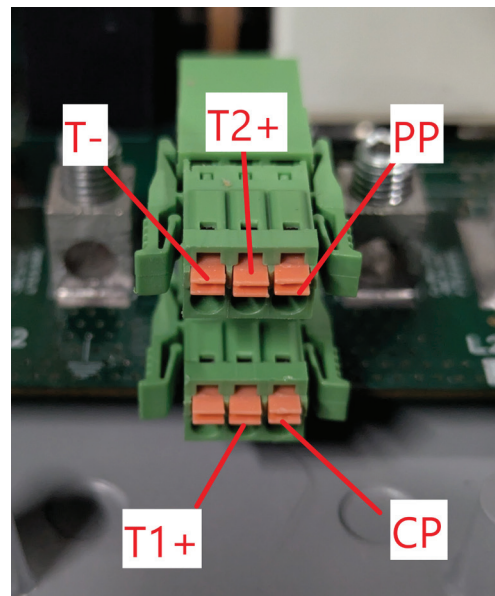

Fig. 17 – Output cable low-voltage connections

5.4. DERATE SWITCH

The Derate Switch on the Shasta 48 & 80 chargers can be used to decrease the maximum AC current offered by the charger. If a modified output configuration is required (based on Table 1 in the Electrical Requirements section), follow these steps to derate the charger's output accordingly.

NOTICE

The Derate Switch must **ONLY** be adjusted by installers or Blink qualified service personnel.

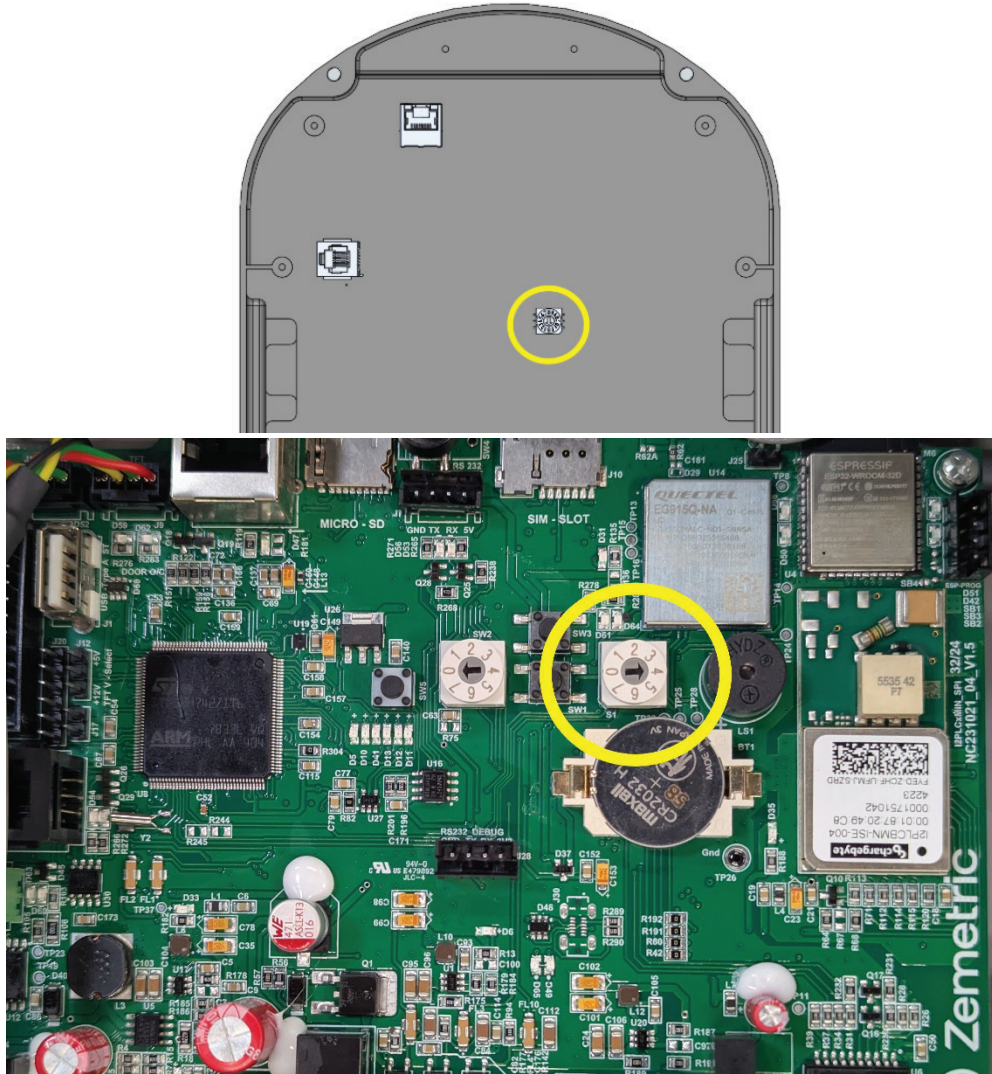

Fig. 18 – Derate switch location (labelled S1)

- To access the derate switch, first remove the charger’s front cover if necessary.
- Using a small plastic screwdriver, set the derate switch (labelled S1) to the appropriate Derated Value from Table 6 below.
- Re-install the Front Cover.

SHASTA 80 DERATE SETTINGS		
CIRCUIT BREAKER SIZE	MAXIMUM OUTPUT	DERATE SWITCH SETTING
100A	80A	7
80A	64A	6
70A	56A	5
60A	48A	4
50A	40A	3
40A	32A	2
30A	24A	1
20A	16A	0

Table 7 – Circuit breaker size vs charger output configuration for Shasta 80

SHASTA 48 DERATE SETTINGS		
CIRCUIT BREAKER SIZE	MAXIMUM OUTPUT	DERATE SWITCH SETTING
60A	48A	7
		6
		5
		4
50A	40A	3
40A	32A	2
30A	24A	1
20A	16A	0

Table 8 – Circuit breaker size vs charger output configuration for Shasta 48

6. CABLE MANAGEMENT SYSTEM (CMS) - PACKAGE CONTENTS

6.1. WALL MOUNT CMS PACKAGE CONTENTS

Part	Qty	Image
CMS Wall Mount Bracket	1	
CMS Wall Mount Head Unit	1	
M12/1/2" Anchor Bolts	4	
CMS Cable Clamp Screw (M3 x 10mm)	2	
CMS Cable Cap Screw (M4 x 25mm Tamper-Resistant Torx)	4	
CMS Wall Mount Head Unit Mounting Screws (M6 x 16mm Tamper-Resistant Torx)	2	
CMS Cable Clamp	1	

Table 9 – CMS package contents

7. CABLE MANAGEMENT SYSTEM (CMS) INSTALLATION

7.1. WALL MOUNTING CMS

7.1.1. SITE SELECTION

The charging station should be positioned such that the distance between the charging station and electric vehicle is sufficient to minimize the likelihood of damage (suggested min. 3 ft). Two alternatives are illustrated below:

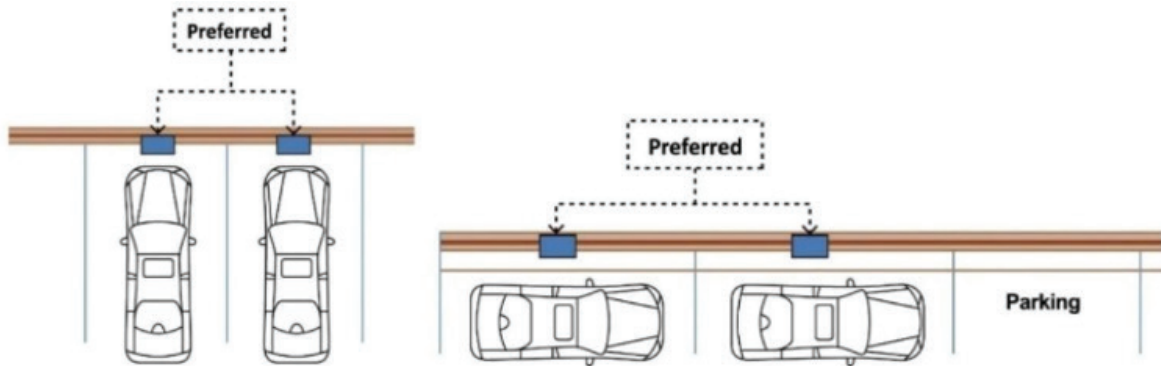

Fig. 19 – Site location recommendations

7.1.2. CMS WALL MOUNT BRACKET INSTALLATION

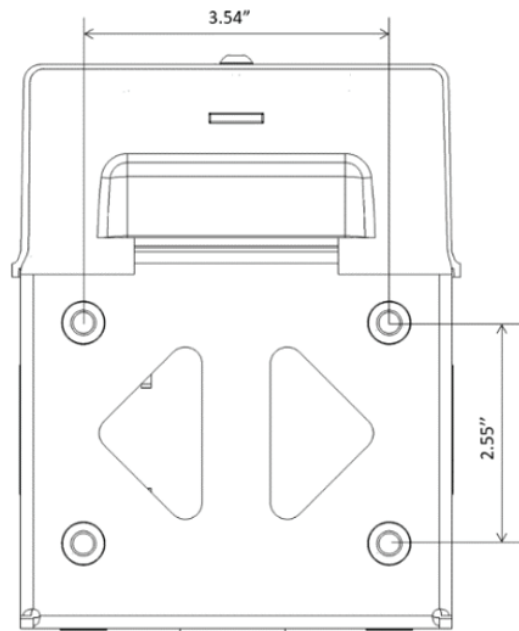

Fig. 20 – Cable management system wall mount bracket template

At the selected location, place the wall mount bracket on the wall such that the top of the bracket is at a height of 91.5 inches (Check local codes).

- If the wall is made of solid concrete or brick, use anchor bolts to secure the wall-mount to the wall. For walls other than concrete, use fasteners appropriate for the material.

7.1.3. CMS WALL MOUNT HEAD UNIT INSTALLATION

- Carefully place the CMS Wall Mount Head Unit on top of the CMS Wall Mount Bracket as shown in the illustration.
- Align the CMS Wall Mount Head Unit with the CMS Wall Mount Bracket.
- Secure CMS Wall Mount Head Unit to the Wall Mount Bracket with (2) M6 x16mm Tamper-Resistant Torx screws (from bottom side).

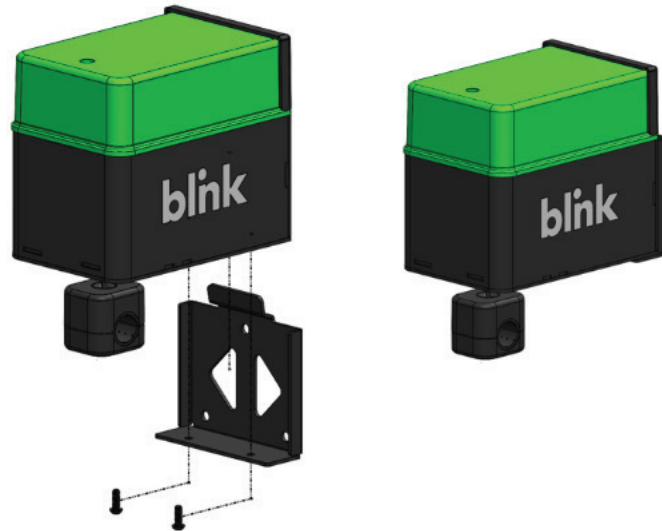

Fig. 21 – CMS wall mount head unit installation

7.1.4. CMS CABLE CLAMP INSTALLATION

- Put both sides of the CMS Cable Clamp at approximately the midpoint of the charging cable.
- Use (4) M3 x 10mm to assemble the CMS Cable Clamp to the charging cable.



Fig. 22 – Installing CMS cable clamp

- Use (2) M4 x 25mm Tamper-Resistant Torx screws to assemble the CMS Cable Bottom Cap to CMS Cable Top Cap

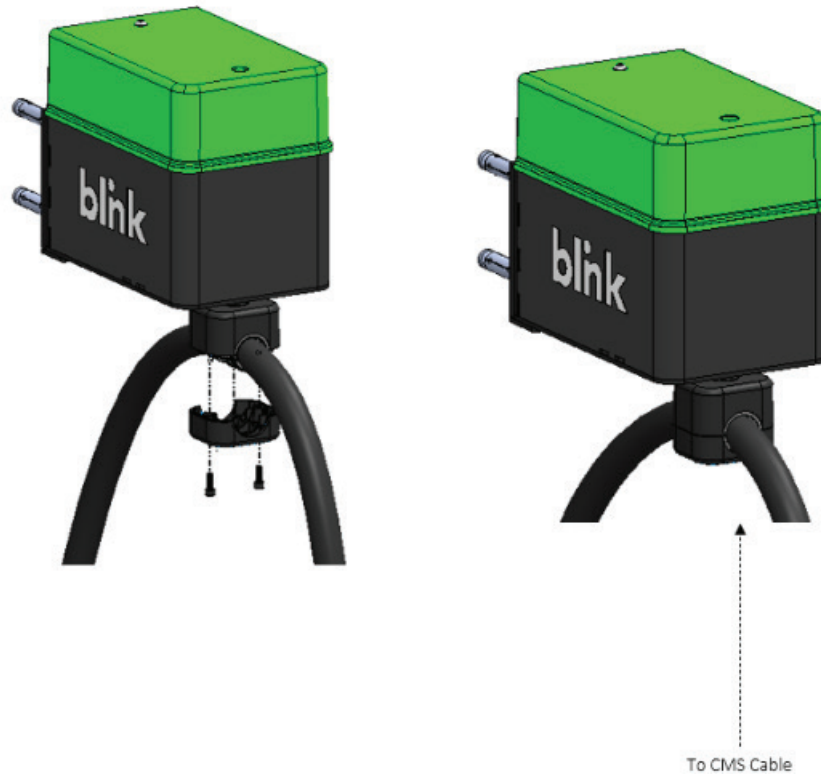

Fig. 23 – Installing CMS cable bottom and top caps

8. COMMISSIONING AND ENERGIZATION

8.1. STATION COMMISSIONING

After the stations have been installed and are energized, please fill out the **Blink Level 2 EVSE Electrical Information form** (linked below) and return it to Onboarding@Blinkcharging.com. You will need the station serial number(s) to complete the form. The serial numbers are located on bottom left-hand side of the station.

<https://blinkcharging.com/resources/evse-installation/blink-level-2-evse-electrical-information-form>

Once the form has been submitted, you will receive a case number (CAS-XXXXX) for your records.

For other inquiries related to station commissioning, please call **Blink Customer Support** at 888-998-2546

If modified output configurations are needed (per the guidelines in the Electrical Requirements section), please provide the following information for each station:

- Panel voltage: **(Example - 120/208V or 120/240V)**
- Circuit numbers & amperage feeding the charging stations: **(Example – CKT 37/39 2 Pole 60A)**
- Serial Numbers connected to each circuit number: **(Example: Z00***** Circuit 37/39)**

If Load Management is needed, please provide the following information for each station:

- Panel(s) name: **(Example – PNL1B)**
- Panel(s) voltage & amperage: **(Example - 120/208V 225A)**
- Circuit numbers & amperage feeding the charging stations: **(Example – CKT 37/39 2 Pole 100A)**
- Serial Numbers connected to each circuit number: **(Example: Z00***** Circuit 37/39)**

8.2. INITIAL POWER-UP SEQUENCE

⚠ CAUTION

Be Aware of High Voltage!

After installation, station registration, and load management and/or modified output configurations have been completed (if applicable) the Blink station is ready to be energized.

1. Verify AC source breaker and any AC source isolation disconnects are OFF and locked out.
2. Verify no AC voltage is present at input terminals.
3. Verify input connections (L1, L2, and Ground/PE) are properly terminated and secure.
4. Check for any damage to the charger enclosure and mounting devices.
5. Verify all AC source equipment covers are installed and equipment is closed securely.
6. Remove Lockout equipment from AC source breaker or AC source isolation disconnect.
7. Energize charger at source breaker or isolation disconnect.
8. Verify AC voltage is 208/240V from L1 to L2 input terminals.
9. Verify AC voltage is 120V from each phase conductor to Ground/PE.
10. Close charger front cover.

8.3. WI-FI SETUP

1. Contact Blink Customer Support at 1-888-998-2546 to obtain the Shasta charger's Wi-Fi password.
2. Power on the Shasta charger. Using a computer, tablet, or smartphone that supports Wi-Fi, browse for available Wi-Fi networks.
3. Connect to the Shasta charger's Wi-Fi network by selecting the SSID (Wi-Fi network name) corresponding to the unit's serial number (displayed on the unit's LCD screen or on the left side of the enclosure).
4. Enter the Wi-Fi password and connect to the network.
5. Once connected to the unit's Wi-Fi network, open an internet browser (Google Chrome, Mozilla Firefox, Safari, etc) and navigate to the IP address: 192.168.4.1

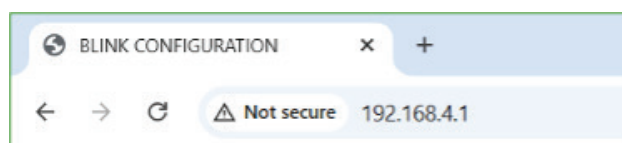

Fig. 24 – Shasta charger IP address

- On the unit's Configuration page, navigate to the STA SSID field, and enter the SSID of the Wi-Fi network the unit will be connected to. Click "Save." The unit should beep twice to indicate the configuration has been updated.
- In the STA Password field, enter the password for the Wi-Fi network the unit will be connected to and click "Save."

The screenshot shows the 'BLINK Configuration' page. It contains five rows of configuration fields, each with a 'Save' button to its right. The fields are: 'OCPP Server' with the value 'wss://csms-uat.blinknetwork.com/ocpp16'; 'Network APN' with the value 'data.apn.name'; 'Firmware URL' which is empty; 'STA SSID' with the value 'Blink'; and 'STA Password' with a masked password '#####'. A red rectangular border highlights the 'STA SSID' and 'STA Password' rows.

Fig. 25 – Setting Wi-Fi SSID and password

- Navigate to the bottom of the Configuration page and set "Enable Wi-Fi" to ON.

The screenshot shows the 'System Controls' page. It features five toggle switches: 'FreeVend Mode' (off), 'Enable Ethernet' (on), 'Enable Wi-Fi' (on), 'Enable Cellular' (on), and 'Power Save' (off). A large red arrow points to the 'Enable Wi-Fi' toggle, which is currently turned on. Below the toggles is a red button labeled 'Reset Device' with a circular refresh icon.

Fig. 26 – Enable Wi-Fi

- Turn power to the unit OFF and back ON. Once the unit is powered back ON, reconnect to the station Wi-Fi network and reload the Configuration page.

10. Confirm that the unit is connected to the correct Wi-Fi network:



Fig. 27 – Confirm Wi-Fi setting

8.4. SIM CARD INSTALLATION

NOTICE

Note: The SIM card slot can only accommodate size 3FF/Micro SIM cards.

- If necessary, remove the charger's front cover
- Locate the SIM card slot at the top of the main PCB and insert the SIM card as shown below:

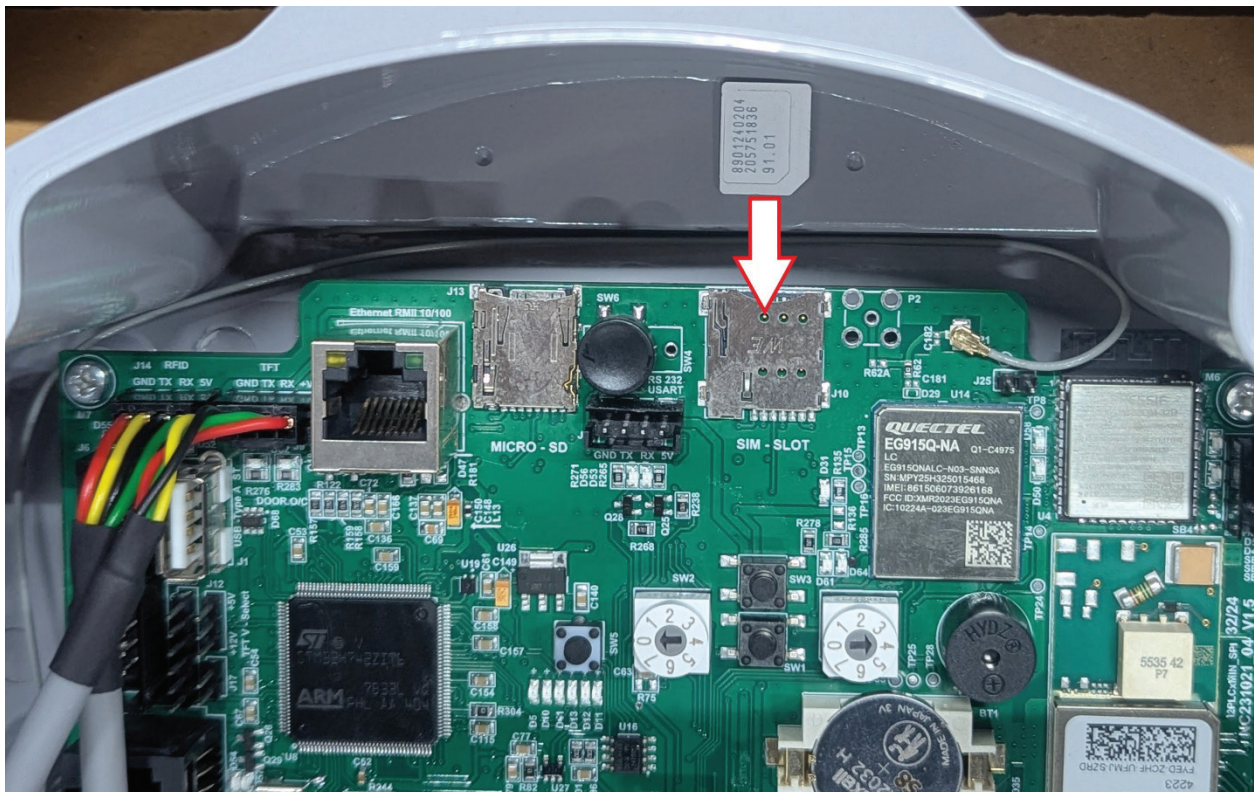

9. OPERATING INSTRUCTIONS

Read all the instructions before operating this product.

9.1. OPERATING PRECAUTIONS

⚠ WARNING

Please make sure that the unit is properly commissioned in accordance with the commissioning instructions before it is used.

⚠ WARNING

Do not use this product if the enclosure or charging connector is broken or open or if it is damaged or has been tampered with.

⚠ WARNING

Do not use the charger if there is water intruding into the charger.

⚠ WARNING

Do not use this product if the power cable or charging cable have any damage.

⚠ WARNING

Do not put any tool, material, finger or other body part into the charging connector or EV connector.

⚠ CAUTION

The product should be inspected by a qualified installer prior to initial use. Under no circumstances will compliance with the information in this manual relieve the user of his /her responsibilities to comply with all applicable codes and safety standards.

9.2. OPERATING INSTRUCTIONS

9.2.1. IDLE STATE

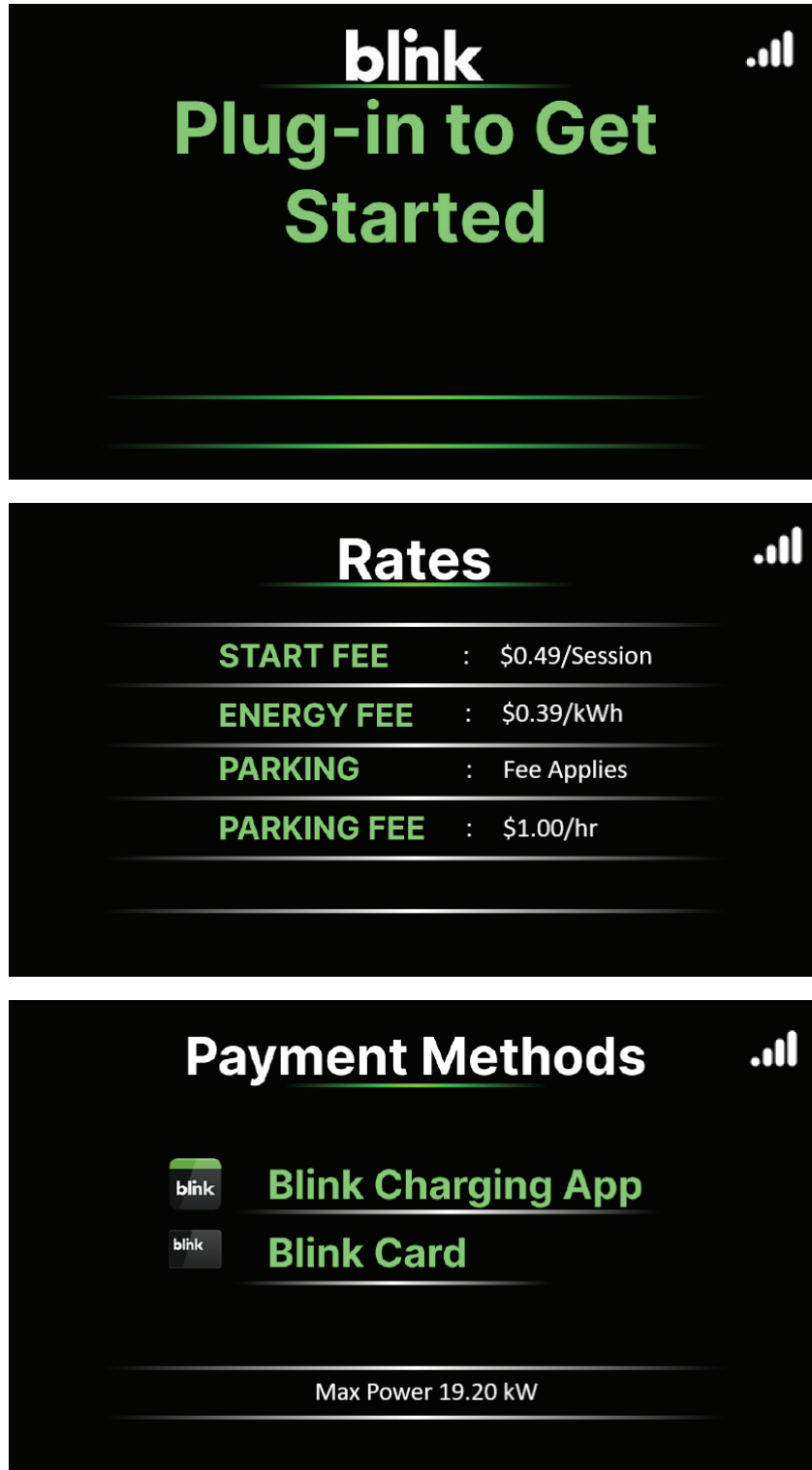

Fig. 28 – Idle State screens

9.2.1. USER AUTHORIZATION

- Authorization can be done via RFID card, mobile app, mobile phone, or QR code (when using the Blink app)
- Authorization can be done either before or after plugging in

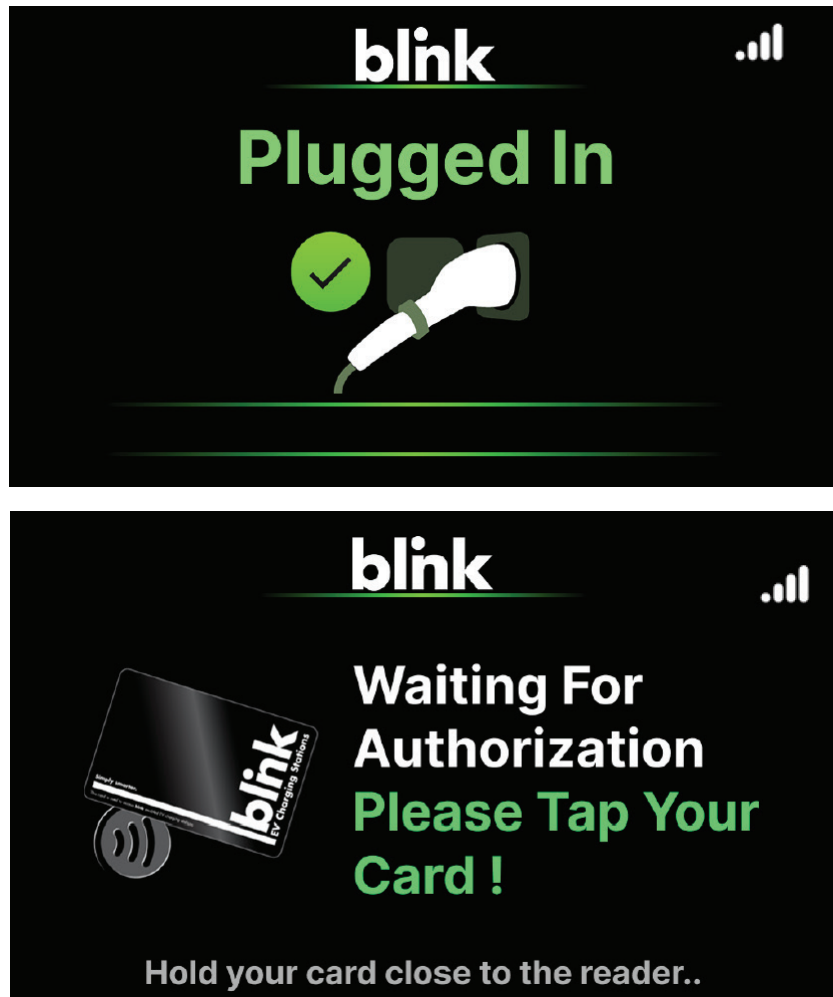

Fig. 29 – User Authorization screens

9.2.3. CHARGING



Fig. 30 – Charging screen

9.2.4. CHARGING COMPLETE

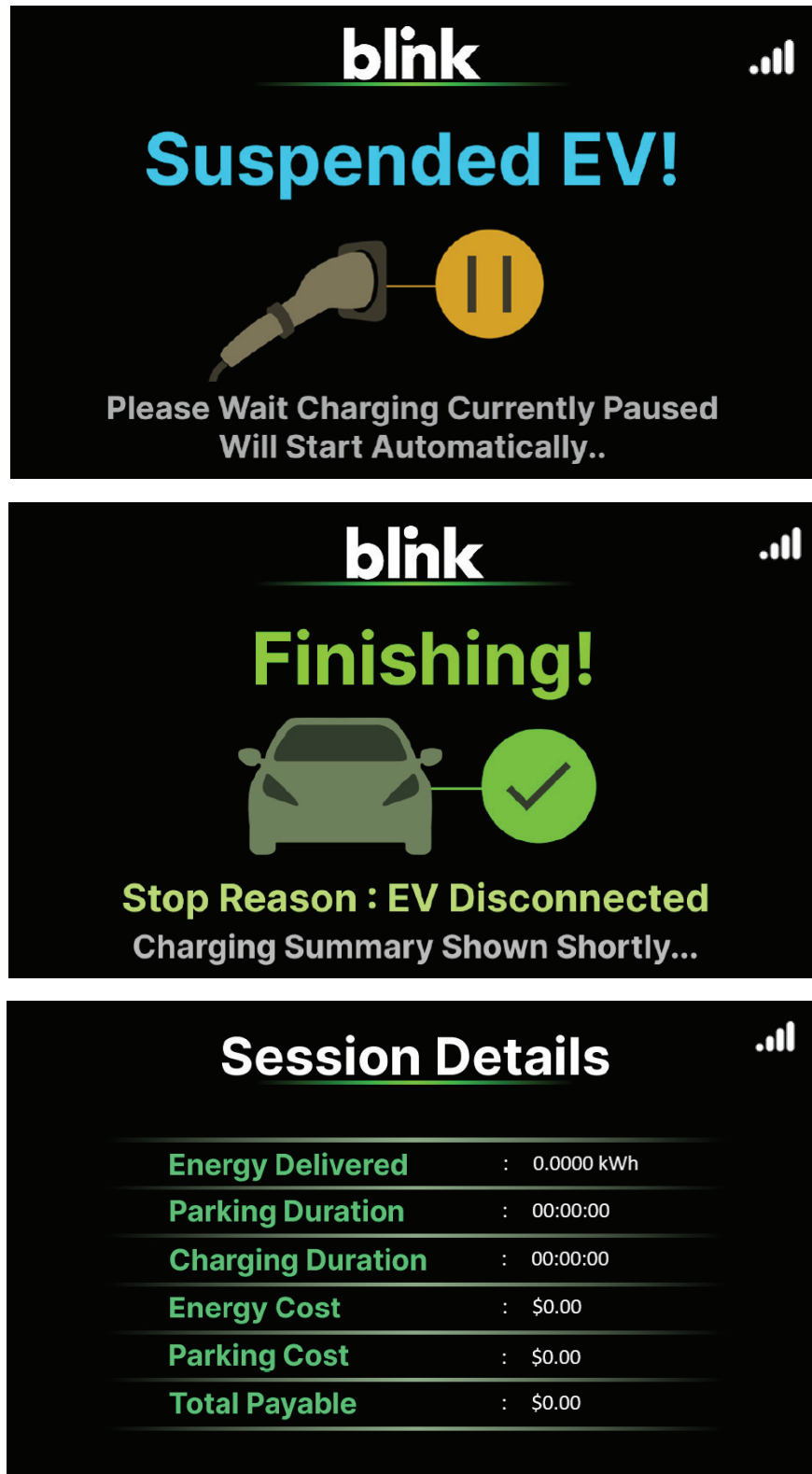

Fig. 31 – Charge Complete screens sequence

9.3. TROUBLESHOOTING

When the charger encounters an error or fault condition, an error message will appear on the screen. An example is shown below:

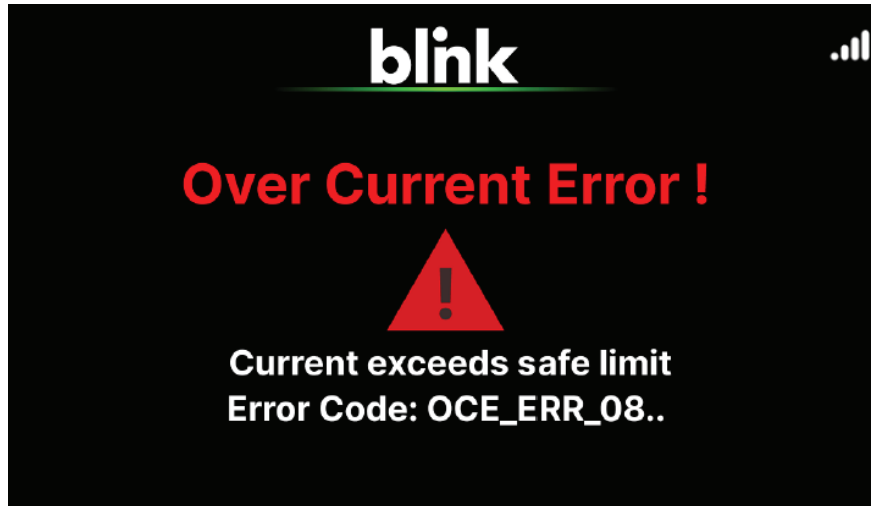

Fig. 32 – Error/fault screen

To report a charger fault or for assistance troubleshooting, contact Blink Customer Support at 888-998-2546

9.4. CUSTOMER SUPPORT

Please contact customer support

- If the enclosure or screen is broken, cracked, opened, or shows any other indication of damage.
- If there is damage to the charging connector, charging cable or holder of the charging connector
- If there is water intruding into the charger, please cut off the power source immediately and contact Blink customer success team for repair.

Please record the status code number (if any) on the LCD monitor before calling customer support.

Contact information for Blink customer support:

Customer Support: 888-998-2546 or support@blinkcharging.com

10. CLEANING AND MAINTENANCE

⚠ WARNING

Blink EV charging stations may be cleaned in accordance with the following guidance:

- Use clean, soft cloth along with mild detergent to wash the dirt off
- Pour water gently from the top and use a wet/dry cloth to clean all the sides
- **Do not use excessive water pressure**
- **Do not use strong detergents or any other chemicals (acids, petrol, thinner, or any other solvent)**

- **Avoid exerting excessive pressure on the device while cleaning**
- **Do not open the device**
- **Do not use a vacuum cleaner**

11. WARRANTY

The Limited Product Warranty (“The Warranty”) applies to the Blink Shasta chargers (stations) purchased from Blink or one of Blink’s authorized distributors or resellers. The Warranty shall cover the station from any manufacturer and/or workmanship defects for the period specified at the time of purchase. Upon verification of a valid warranty claim, Blink shall repair the station.

The following instances and events are not covered under the warranty policy (exclusions):

- Damage due to factors out of supplier’s control such as power surges, lightning, earthquake (i.e., “Acts of God”), etc.
- Damage due to negligence, failure to maintain the product, or any other event beyond Blink Charging’s reasonable control
- Alteration and/or modification to the product without prior approval from with Blink Charging
- Use of software, interfaces or parts not approved by Blink Charging
- Any damage to the EV charging cord unless it is the result of manufacturing defects in the cord or connector assembly
- Acts of vandalism
- Abuse, physical damage, misapplication, or damages due to station usage not outlined in official Blink documentation
- Installation or relocation of the station unless performed by a certified electrician or Blink approved technician
- Improper site preparation or maintenance
- Consumables such as RFID card, cable, internal wires and connectors

For additional information about the warranty policy, please refer to the official Blink Limited Warranty documentation or contact a Blink representative via the contact information provided in this document.